

**Chief Architect®  
Home Designer Essentials® 2014**

**User's Guide**

**Chief Architect, Inc.  
6500 N. Mineral Dr.  
Coeur d'Alene, Idaho 83815  
[www.HomeDesignerSoftware.com](http://www.HomeDesignerSoftware.com)**

© 1990–2012 by Chief Architect, Inc. All rights reserved.

No part of this book or the accompanying software may be reproduced or transmitted in any form or by any means, electronic or mechanical, including photocopying, recording, or by any information storage and retrieval system, without permission in writing from Chief Architect, Inc.

Chief Architect® and Home Designer® are registered trademarks of Chief Architect, Inc.

This software uses the FreeImage open source image library. See <http://freeimage.sourceforge.net> for details.

FreeImage is used under the FIPL license, version 1.0.

This software uses the Ruby open source library. See <http://www.ruby-lang.org/> for details.

All other trademarks and copyrights are the property of Chief Architect, Inc. or their respective owners.

Created in the United States of America.

# Contents

---

## Chapter 1: Installation

System Requirements .....	7
Downloading Home Designer Essentials .....	8
Installing Home Designer Essentials .....	9
Starting Home Designer Essentials .....	15
Migrating Library Catalogs .....	19
Program Updates .....	20
Installing on Multiple Computers .....	21
Uninstalling Home Designer Essentials .....	21

---

## Chapter 2: House Design Tutorial

Before You Begin.....	24
Getting Started.....	24
Setting Defaults .....	27
Drawing Walls .....	29
Creating Dimension Lines .....	32
Adjusting Wall Positions.....	33
Creating Rooms .....	35
Creating a 3D View .....	42
Adding Floors .....	45
Adding Stairs .....	50
Placing Doors and Windows .....	54

---

## Chapter 3: Roof Tutorial

Getting Started with Roofs .....	61
Deleting Roofs .....	62
Hip Roofs.....	63
Gable Roofs .....	64
Shed Roofs.....	65
Saltbox Roofs .....	66
Gambrel Roofs.....	67
Gull Wing Roofs.....	68
Half Hip Roofs.....	69
Mansard Roofs.....	71
Roof Type Quick Reference.....	73
Adding Gables over Doors and Windows .....	74
Manually Drawn Dormers .....	75
Skylights.....	81
Using the Break Wall Tool to Modify Roofs .....	82
Adding a Roof .....	85
Troubleshooting Roof Issues.....	88

---

## Chapter 4: Interior Design Tutorial

Controlling the Display of Objects.....	93
Working with Library Objects.....	94
Applying Room Moldings .....	98

---

## Chapter 5: Kitchen and Bath Design Tutorial

Adding Cabinets .....	103
Placing Appliances.....	108
Editing Cabinets and Appliances.....	109
Creating a Custom Countertop .....	112
Working in 3D Views .....	115

---

## **Chapter 6: Materials Tutorial**

Setting Materials Defaults .....	119
Using the Materials Tab .....	121
Using the Material Painter .....	123
Blending Colors with Materials .....	126
Using the Material Eyedropper .....	127
Custom Materials, Images, and Backdrops .....	129
Generating a Materials List .....	135

---

## **Chapter 7: Landscaping Tutorial**

Creating a Terrain Perimeter .....	138
Adding a Driveway .....	141
Adding Terrain Features .....	143
Adding Library Objects to Your Plan .....	146

---

## **Chapter 8: Deck Tutorial**

Decks and Porches .....	149
Drawing Decks .....	150
Drawing Stairs .....	151
Adding Exterior Furniture .....	151

---

## **Appendix A: End User License Agreement**



# Installation

This chapter will walk you through installing your Home Designer software.

## Chapter Contents

- System Requirements
- Downloading Home Designer Essentials
- Installing Home Designer Essentials
- Starting Home Designer Essentials
- Migrating Library Catalogs
- Program Updates
- Installing on Multiple Computers
- Uninstalling Home Designer Essentials

---

## System Requirements

In order to install and run Home Designer Essentials, your computer system must meet the following minimum requirements:

- 32- or 64-bit Windows<sup>®</sup> 8, 7, or Vista; 32-bit Windows<sup>®</sup> XP
- 2.4 GHz processor
- 2 GB of memory
- 5 GB of available hard disk space
- 256 MB of dedicated on-board video memory, OpenGL 2.1 or higher
- Monitor resolution: 1024 x 768

- High speed Internet for registration, video access, content downloads
- DVD drive (if software purchased on DVD)

For more information about system recommendations, visit our Web site at [www.HomeDesignerSoftware.com](http://www.HomeDesignerSoftware.com).

---

## Downloading Home Designer Essentials

To download and install Home Designer Essentials 2014, you will first download the Home Designer Essentials download Manager, and then use it to download the Home Designer Essentials 2014 installer.

1. Log in to your online Home Designer Essentials account and browse to the Digital Locker page.
2. Click the  button.
  - If your internet browser asks you to confirm whether to Run or Save the file, select **Run**.
  - If you prefer to click **Save**, the Save As dialog will open. Select an easy to find **Save in** location on your computer, such as your Documents folder or Windows Desktop, then click **Save**.
3. The **Download Complete** dialog may display when the file is finished downloading. If it does, click the **Run** button to continue.
4. An **Internet Explorer - Security Warning** message may display next. If it does, click the **Run** button to continue.
  - If the Downloader does not launch, browse to the location where you saved it on your computer and double-click it.
5. The **Save To - Home Designer Essentials Downloader** dialog will open next.
  - Click the **File** button if you would like to select a different location on your computer to save the Home Designer Essentials installer.
  - Click **OK** to begin the download.
6. The **Home Designer Essentials Downloader** progress dialog will open next. The installer is over 100 MB, so may take some time to download, depending on your Internet connection.
  - The **Saving To** section of the dialog box states the location on your computer where the installer is being saved and its name.
  - The **Progress** section indicates how much of the installer has been downloaded thus far, how fast it is being downloaded and estimates how much more time will be needed.
7. If you wish, click the **Options** button and choose whether to:
  - **Run This Program When Done** downloading. This option is selected by default. Click to uncheck it if you prefer to run the installer at a later time.
  - **Finish Downloading Later**. Select this option to stop the download. You can later resume where you left off by double-clicking on either the Download Manager acquired in steps 2 and 3 above or the Finish Downloading Home Designer Essentials 2014 shortcut created on your



Windows Desktop. This shortcut is created only when this option is chosen and is deleted when the download is completed.

- Use **Proxy Server Settings**. Choose this option only if you use a proxy server.
8. You can click the **Pause** button to temporarily halt the download. You can then click the **Resume** button to continue it.
  9. You can also click the **Cancel** button to cancel the download entirely. The downloader will ask you if you would like to finish later: click **Yes** to Finish Download Later, as described above; click **No** to cancel the download and start again later.

---

## Installing Home Designer Essentials

When the file is completely downloaded, the Home Designer Essentials Setup Wizard will launch automatically.

If you have an Home Designer Essentials Program DVD, insert it into your DVD drive. The Home Designer Essentials Setup Wizard will launch.

If the Setup Wizard does not launch when you insert the disk into your DVD drive, you can open it manually. Click the Windows Start button, then select Computer. Right-click on your DVD drive and select Open from the menu, then double-click on the file with your program's name and the .msi file extension.



## Setup Wizard Welcome

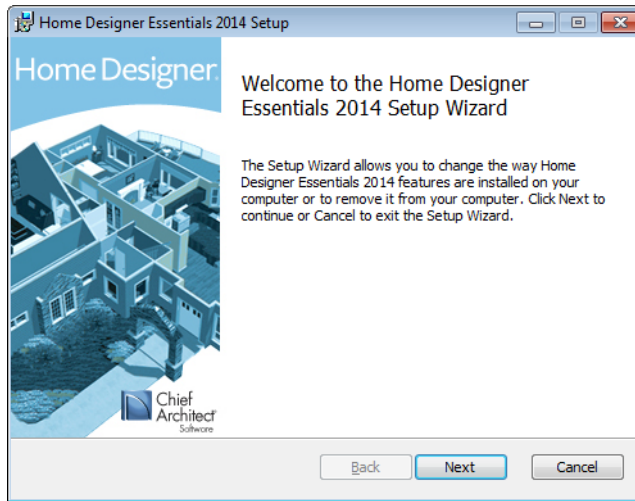

1. Depending on whether or not you have installed the program on this computer before, the text in this window may vary. Click **Next** to continue.

## Setup Maintenance

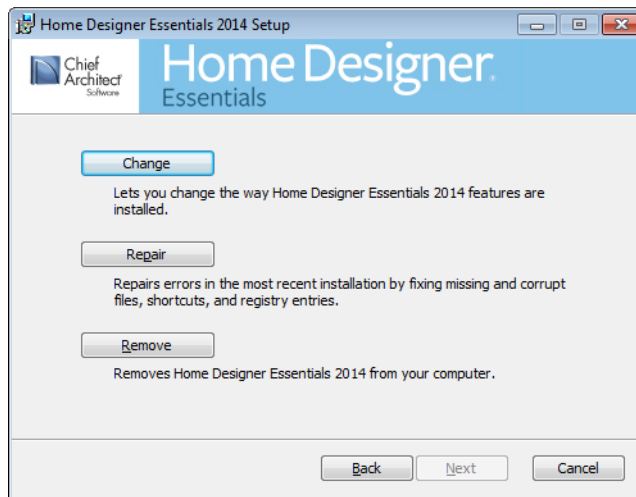

2. If you have installed the program before, this window will display, allowing you to reinstall or uninstall the program. If you are installing the program for the first time, this window will not display.

## License Agreement



3. Read the License Agreement carefully. You must check the box beside **I accept the terms and conditions of this license agreement** before installing. See “End User License Agreement” on page 153 of the User’s Guide.
  - Click the **Advanced** button if you’d like to specify a non-default installation location or exclude supplementary content from being installed.
  - Click **Install** to begin installing the software. The Setup Wizard will begin copying files to your hard disk. This may take a few minutes.

## Choose Destination Location

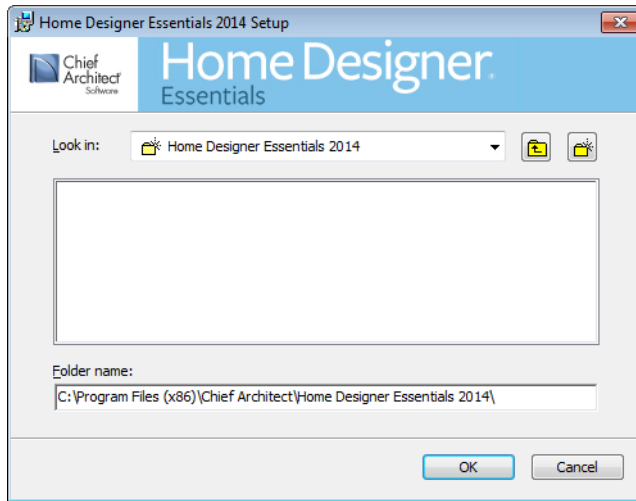

4. This window appears only if you click the **Advanced** button, and then the **Change** button, in the previous windows. Choose the destination folder for the program. By default, the program installs in the C:\Program Files\Chief Architect directory, in a folder with the same name as your program version.
  - If you prefer a different location, click drop-down arrow to the right of the **Look in:** location and navigate to the desired location on your hard drive.
  - You can also type the full pathname of the installation directory in the **Folder name:** field.
  - Click **OK** to proceed to the next window.

Note: Regardless of the location that you specify here, the program's library content will be installed in your computer's ProgramData folder (All Users\Application Data on Windows XP).

## Choose Items to Install

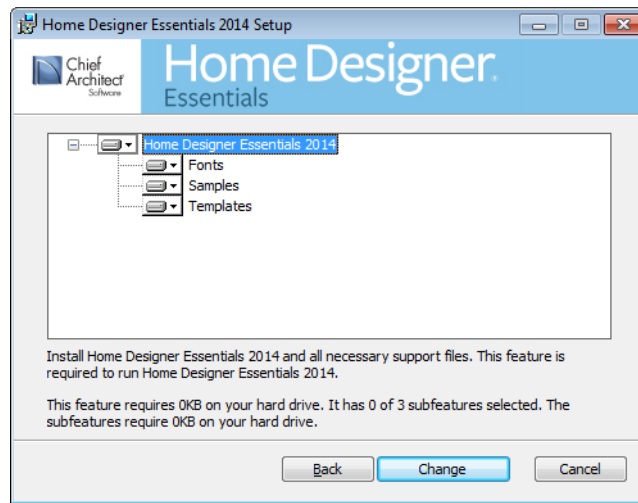

5. You can use this window to specify what features you wish to install.
  - Click on a line item to select it. Information about its contents and hard drive space requirements displays beneath the list of features.
  - Click the drop-down arrow beside a line item to specify how it is installed. By default, **Entire feature will be installed** is selected for all line items.
  - Choose **Entire feature will be unavailable** to prevent a selected subfeature from being installed. When this option is selected, a red X will display beside the line item's drop-down arrow. The top level feature cannot be excluded from installing. If you decide to not proceed with the program installation, click the Cancel button.
  - Click **Install** to install the program and supplemental content as specified.

## Install

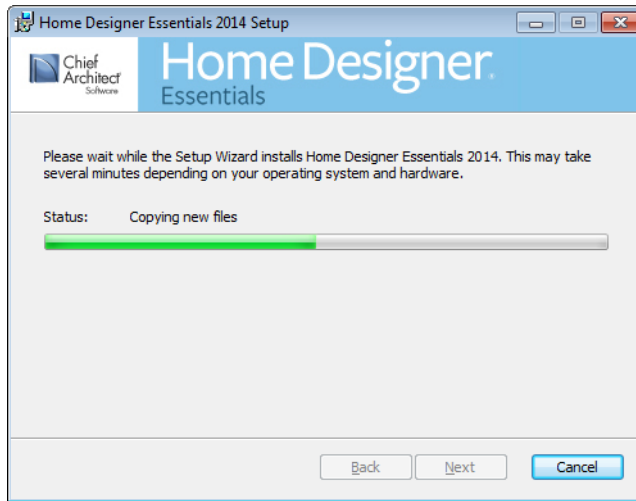

6. The Setup Wizard will begin copying files to your hard disk after a few moments and a green progress bar in this window will show the status of this process. This may take a few minutes.

## Setup Wizard Complete

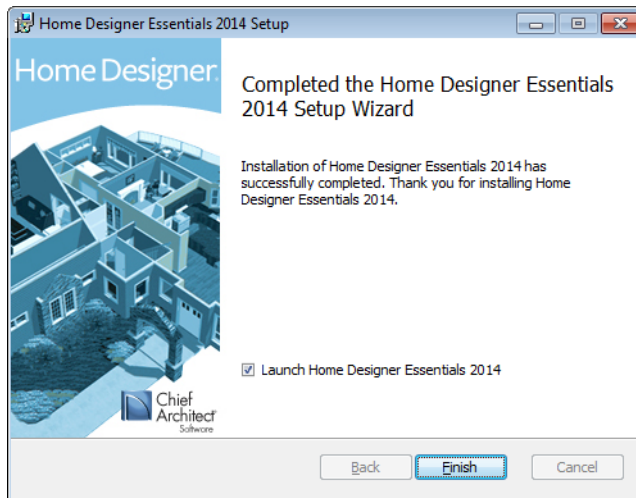

7. When all files have been copied, this dialog will display. Click **Finish** to launch Home Designer Essentials.

---

## Starting Home Designer Essentials

You can use the Start menu or the shortcut on your desktop to start Home Designer Essentials. When you launch the program for the first time, the Registration Wizard will open.

Take a moment to complete the Registration Wizard, which authenticates your right to use this product and gathers information which may be used to notify you of free updates and other important information. Please be assured that Chief Architect Inc never sells or shares this information with other parties.

### Registration Wizard



1. In the Welcome window, click **Next** to continue.

## Enter Product Key

The screenshot shows a dialog box titled "Home Designer Secure Registration Wizard" with a close button in the top right corner. The main heading is "Enter Product Key". Below the heading, there is explanatory text: "The Product Key is used to uniquely identify your copy of Home Designer. Your Product Key can be found in or on your DVD case or in the account information from your download." A horizontal line separates this text from the instructions below: "Please enter the Product Key that came with your program. This key must be entered correctly in order to continue. Example: 23456-789AB-CDEFG-HJKLM". Below the instructions is a single-line text input field. At the bottom of the dialog, there are four buttons: "< Back", "Next >", "Cancel", and "Help".

2. Enter your Product Key, which is located in the account information from your download or on a sticker inside your DVD case.

## User Information

The screenshot shows a dialog box titled "Home Designer Secure Registration Wizard" with a close button in the top right corner. The main heading is "User Information". Below the heading, there is explanatory text: "This information is used to identify you as the registered user of this product. \* indicates required items." A horizontal line separates this text from the instructions below: "Please enter the following information." Below the instructions are four text input fields, each with a label: "Name: \*", "Company Name:", "Phone Number:", and "E-mail Address: \*". Below the input fields is a note: "Note: This information is used to authenticate your right to use this product and to notify you of free updates and important information." At the bottom of the dialog, there are four buttons: "< Back", "Next >", "Cancel", and "Help".



3. Enter your contact information. When you click **Next**, you will be asked to confirm your e-mail address.

## Mailing Address

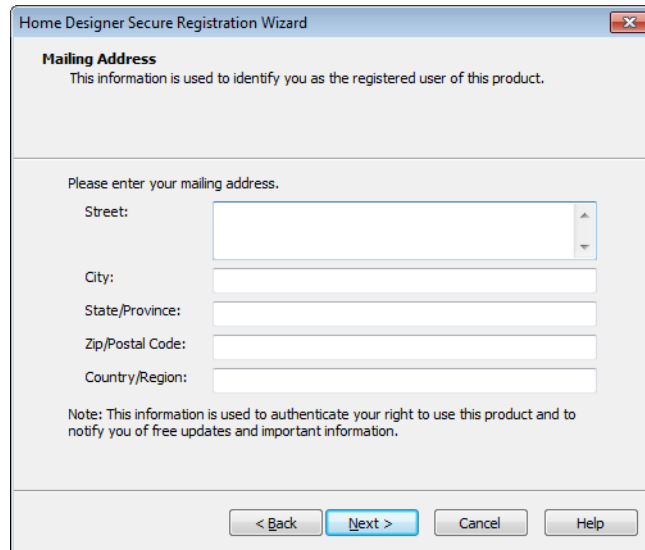

The screenshot shows a dialog box titled "Home Designer Secure Registration Wizard" with a close button (X) in the top right corner. The main heading is "Mailing Address" and the subtext reads "This information is used to identify you as the registered user of this product." Below this, it says "Please enter your mailing address." and lists five input fields: "Street:" (a larger text box with a vertical scrollbar), "City:", "State/Province:", "Zip/Postal Code:", and "Country/Region:". A note at the bottom states: "Note: This information is used to authenticate your right to use this product and to notify you of free updates and important information." At the bottom of the dialog are four buttons: "< Back", "Next >" (highlighted in blue), "Cancel", and "Help".

4. Enter your mailing address and click **Next** to continue.

## Online Registration

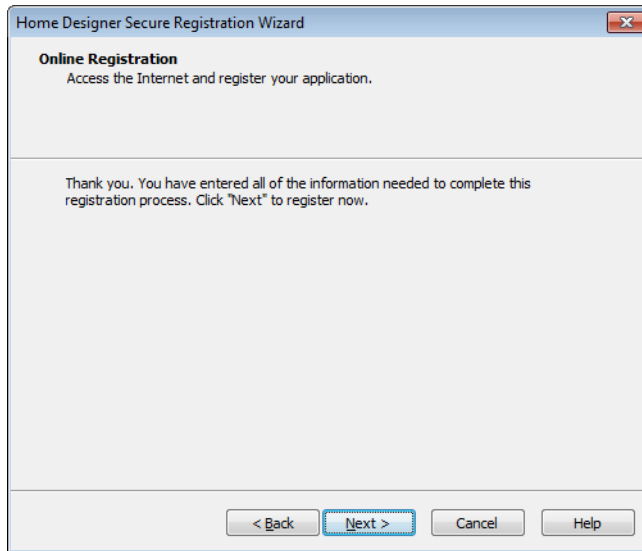

5. Click the **Next** button to register online. An internet connection is required to continue.

## Completing the Registration Wizard



6. To complete the Registration Wizard:
  - Click **Print Registration Information** to print a copy of the registration for your own records.
  - Click **Finish** to close the Registration Wizard and launch Home Designer Essentials.

---

## Migrating Library Catalogs

If you have Home Designer Essentials 2012 installed on our computer, the **Migrate Library Catalogs** dialog will display after you complete the Registration Wizard, allowing you to migrate library content for use in Home Designer Essentials 2014. See “Library Content” on page 287 of the Reference Manual.

### Migrate Library Catalogs Dialog

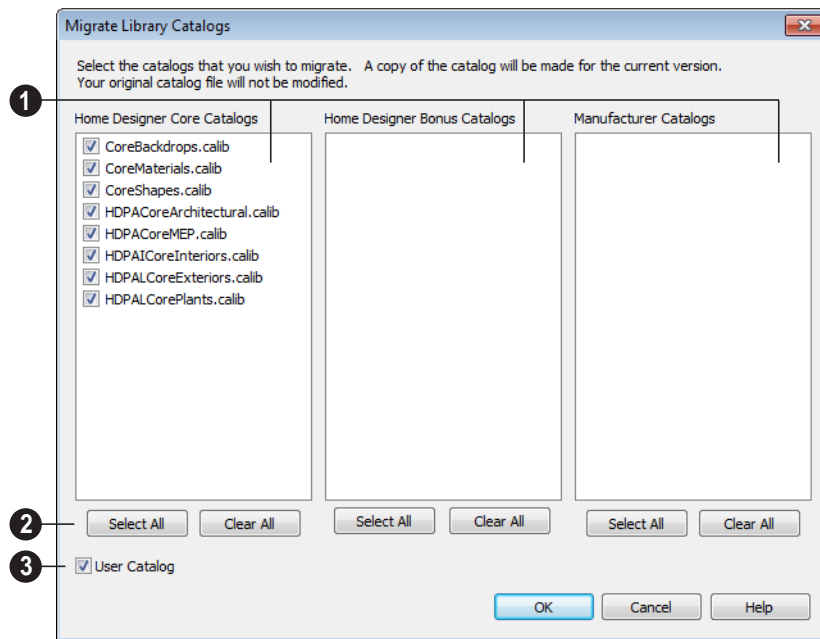

- 1 A list of all **Home Designer Core**, **Home Designer Bonus** and **Manufacturer Catalogs** installed in your version 2012 library display here.
  - Uncheck the box beside a library catalog’s name to prevent it from migrating into the version 2014 Library Browser.

## 2 Select All/Clear All -

- Click the **Select All** button below a list to migrate all catalogs in that list into the version 2014 library.
- Click the **Clear All** button below a list to migrate none of the catalogs in that list into the version 2014 library.

- 3 Uncheck **User Catalog** if you do not want to migrate your custom library content into version 2014. When this is checked, your version 2012 custom library content will be migrated and placed in your User Catalog.

## Legacy Library Conversion

If you upgraded to Version 2014 directly from Home Designer Essentials 10, 9, or 8 and have custom library content from that version on your computer, the **Legacy Library Conversion** dialog will display.

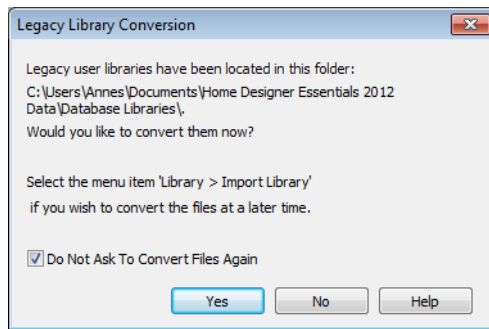

To convert this custom content for use in Version 2014, click **Yes**.

---

## Program Updates

From time to time, Chief Architect releases Home Designer Essentials program updates that are available for download free of charge from the Home Designer Essentials Web site, [www.HomeDesignerSoftware.com](http://www.HomeDesignerSoftware.com).

When a program update is available, this dialog will display when the program is opened:

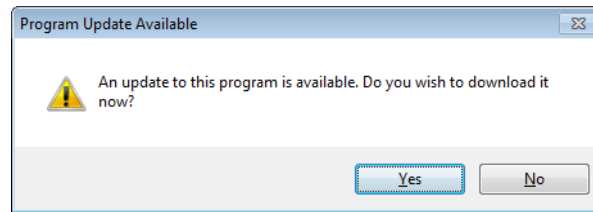

- Click **Yes** to open your default Internet browser to the **Program Updates** section of the Home Designer Web site.
- Click **No** to launch Home Designer Essentials.

At any time, you can select **Help > Download Program Updates** from the Home Designer Essentials menu to launch your default Web browser to the **Program Updates** section of the Home Designer Web site.

Program updates are not patches: when an update is installed, the previous version is uninstalled and then the new version is installed. Library content, Preference settings, and custom, user-specific data like toolbar configurations and template files, are not affected by program updates.

## Installing on Multiple Computers

Licenses of Home Designer Architectural, Home Designer Suite, Home Designer Essentials, Home Designer Landscape & Deck, and Home Designer Interiors can be installed on up to three different computers at a time for personal use. If you wish to install on a fourth computer, you will need to first uninstall off of one of the computers while an Internet connection is active. If you wish to rename a computer, you

For details, please refer to the **End User License Agreement**, found in both the program installer and the User's Guide .pdf.

A license of Home Designer Pro can be installed on as many computers as you wish, but can only be active on one machine at a time. To switch from one computer to another, you must deactivate your license.

## Uninstalling Home Designer Essentials

There are two ways that Home Designer Essentials can be removed from your computer: from the Control Panel and using the Setup Wizard on the program disk. Please note that if you do not have an active Internet connection, your license will not become deactivated.

*To remove the program using the Control Panel*

1. Double-click the Computer icon on your desktop.
2. Open the Control Panel.
3. Double-click Programs (in Windows XP, “Add or Remove Programs”).
4. Find Home Designer Essentials and click **Remove**.

*To remove the program using the Setup Wizard*

1. Place the disc in the DVD drive and select **Install** Home Designer Essentials from the Home Designer Essentials startup window.
2. On the Setup Maintenance page, select **Uninstall** and click **Next**. A message will display, asking if you would like to remove the selected application and its components.
3. Click **Yes** to remove Home Designer Essentials.

When Home Designer Essentials is uninstalled, the Home Designer Essentials Data folder is not removed from the system. See “Home Designer Essentials Data” on page 32.



If an emergency forces you to reformat your hard drive, reinstall Windows, or resort to a system restore point, be aware that none of these actions result in a normal program uninstallation or license deactivation.

# House Design Tutorial

This House Design Tutorial shows you how to get started on a design project. The tutorials that follow continue with the same plan. When we are finished, we will have created a sample plan named “Stucco Beach House.” You can then apply the tools and techniques learned to your own plans.

In this tutorial you will learn about:

- Before You Begin
- Getting Started
- Setting Defaults
- Drawing Walls
- Creating Dimension Lines
- Adjusting Wall Positions
- Creating Rooms
- Creating a 3D View
- Adding Floors
- Adding Stairs
- Placing Doors and Windows

## Before You Begin

Home Designer Essentials may look differently on your screen than it does in the following tutorials.

- Screen captures are taken from a smaller window to optimize image quality, so the size and proportion of your interface may be different.
  - As the program is updated, features may be added or removed. If you are using the latest version of Home Designer Essentials, you may see buttons and/or menu items that have been added or removed since this tutorial was written. For more information, see “Program Updates” on page 20.
  - Depending on your operating system and Windows system settings, dialogs and toolbars may appear differently than they do in the tutorials.
- 

## Getting Started

We'll start with a new, blank plan.



### *To start Home Designer Essentials*

1. Click the Windows Start button and select All Programs.
2. Browse to Chief Architect> Home Designer Essentials 2014> Home Designer Essentials 2014, and click to start the program.



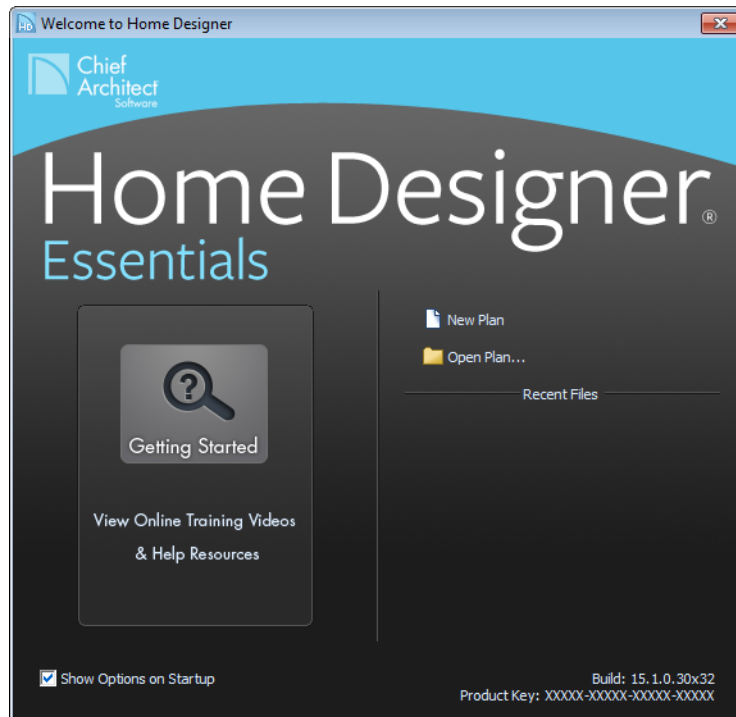



- When Home Designer Essentials launches, the **Getting Started** window displays. For more information, see “Startup Options” on page 17 of the Reference Manual.

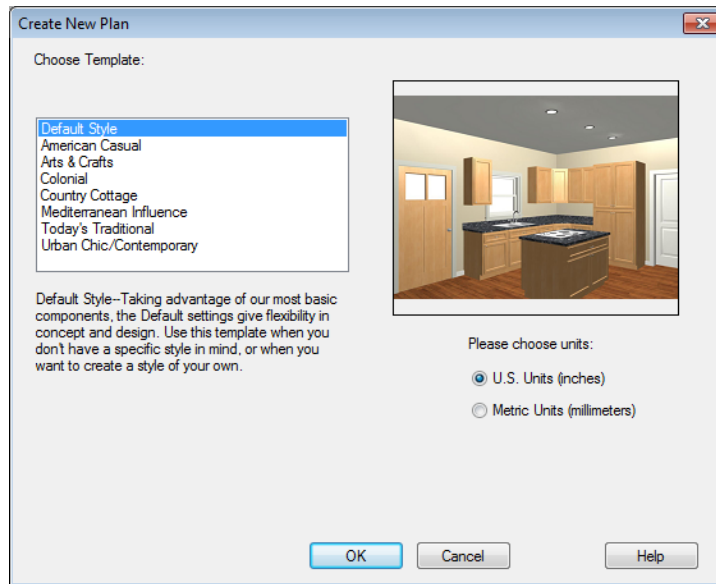

- Click **New Plan**  to open a new, blank plan.
- If you have disabled the Startup Options at startup or already have the program open, you can select **File> New Plan**  to open a new, blank plan.

4. The **Create New Plan** dialog displays next.



5. Home Designer Essentials includes a selection of template plans, each with different default settings that allow you to begin working in a particular plan style quickly. The **Default** template and **U.S. Units** are selected by default. Click **OK**. The floor plan view window opens, ready for you to begin drawing.
6. You should begin work on any new file by saving it. To do this:
  - Select **File> Save**  from the menu to open the **Save Plan File** dialog.
  - Specify the location on your computer where you would like to save the plan.
  - Type a name for your plan.
  - Click **Save**.
7. It is wise to save your work, and save it often, as you proceed. To do this, you can:
  - Select **File> Save**  from the menu to open the **Save Plan File** dialog
  - Click the **Save**  button on the toolbar.
  - Type Ctrl + S on your keyboard.

For more information about saving files, see “Saving, Exporting, and Backing Up Files” on page 33 of the Reference Manual.

---

## Setting Defaults

Default settings determine the initial characteristics of objects when they are first drawn. Before we draw walls and create rooms, we should always make sure the defaults will meet our needs for the current project.

### *To set the Dimension Defaults*

1. Select **Edit> Default Settings**  to open the **Default Settings** dialog.
2. Click on "Dimension" and click the **Edit** button.

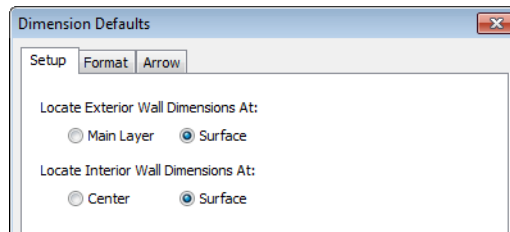

3. Review each of the tabs and settings available for setting up your Dimension Defaults. For more information, see [Dimension Defaults Dialog](#).

### *To set the Floor Defaults*

1. Select **Edit> Default Settings**  to open the **Default Settings** dialog.

2. Select "Floor" from the list and click the **Edit** button to open the **Floor Defaults** dialog.

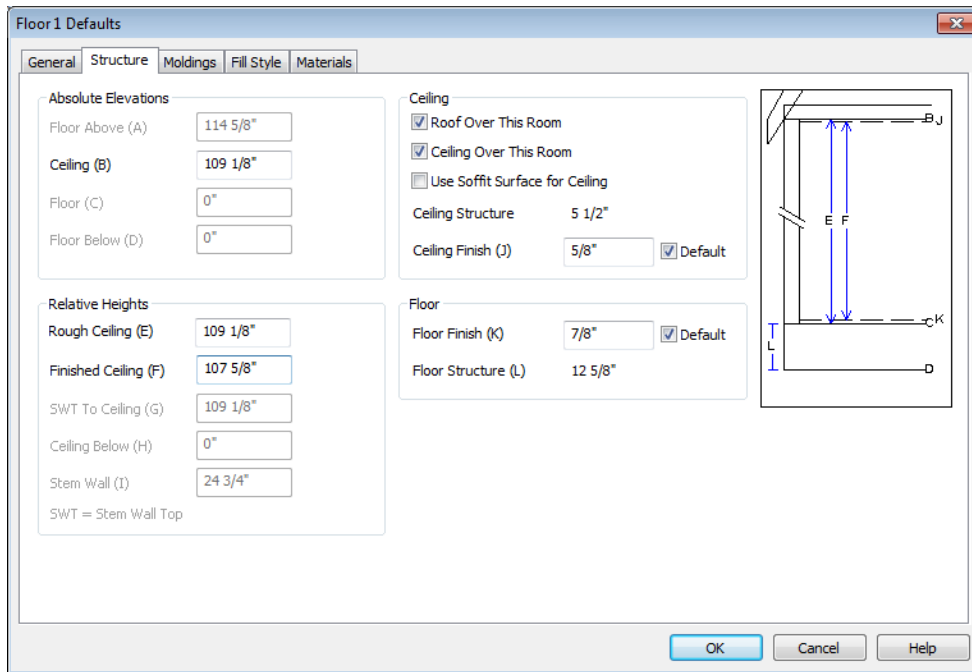

3. On the Structure tab, note the **Ceiling Height**. The initial value is 109 1/8" (inches). We will leave this value unchanged for this tutorial.
4. Click OK to close the **Floor Defaults** dialog.
5. For more information, see "Floor Defaults Dialog" on page 171 of the Reference Manual.

### *To set the Wall Defaults*

1. Select **Edit> Default Settings**  to open the **Default Settings** dialog.
2. Click on Walls, and click on the **Edit** button.

- From the Exterior Wall drop down menu, we will select Stucco-6, and click OK.

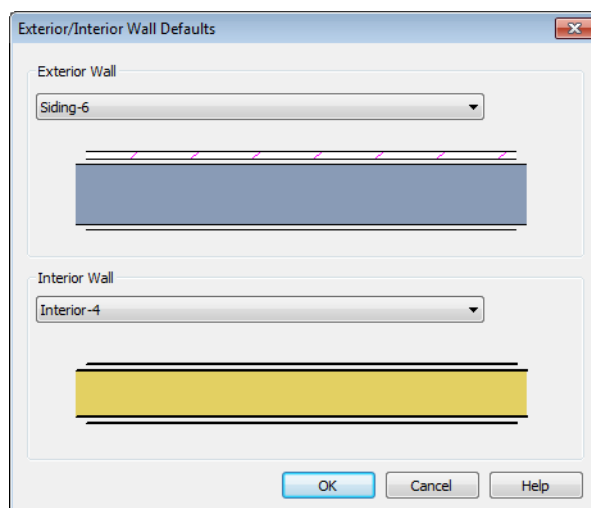

- Click the **Done** button to close the **Default Settings** dialog.

You may want to review some of the other available defaults when setting up your template. For example, you can modify your Cabinet defaults, where you can set up your materials for Base, Wall and Full Height Cabinets so that any future cabinets placed in the plan will initially use these default settings.

## Drawing Walls

We'll start by drawing some exterior walls. When drawing walls, do not try to size or position them precisely - they can be more easily positioned after they are created. For more information, see "Walls, Railings & Fencing" on page 96 of the Reference Manual.

### *To draw exterior walls*

- Select **Build> Wall> Straight Exterior Wall**  from the menu or click the corresponding toolbar button.

- Click and drag from left to right to draw a wall.

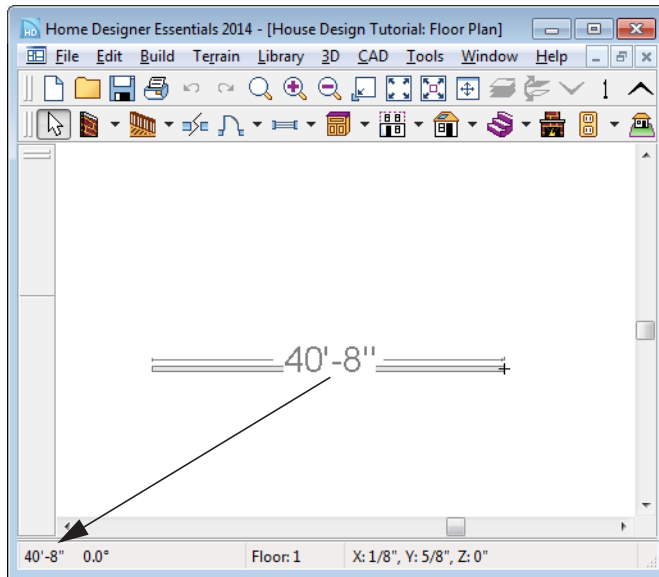

*Wall length is indicated in the Status Bar as the wall is drawn*

2. There are a few things to make note of as you draw a wall.
  - The wall's length displays in two places: above the wall and in the Status Bar at the bottom of the screen.
  - Wall angles are restricted to increments of  $7.5^\circ$  . . See "Snap Behaviors" on page 63 of the Reference Manual for more information.
3. Continue drawing walls, creating a rough outline of the building's exterior, as shown in the following image.
  - Exact dimensions are not important yet, but it is helpful to keep the final size of the structure in mind as you draw. The overall length of this building's sides will be 41' x 39'6".
  - It is important that exterior walls (and any other wall types with an interior side and an exterior side) are drawn clockwise to ensure the proper orientation of wall surfaces.
  - When the walls enclose an area completely, a Living Area label is created. See "Living Area" on page 127 of the Reference Manual.

- When your walls completely enclose an area, a roof will automatically be generated. For the purposes of this tutorial, this roof can be removed. Select **Build> Roof> Delete Roof** . When asked if you want to turn **Auto Rebuild Roofs** off, click Yes.

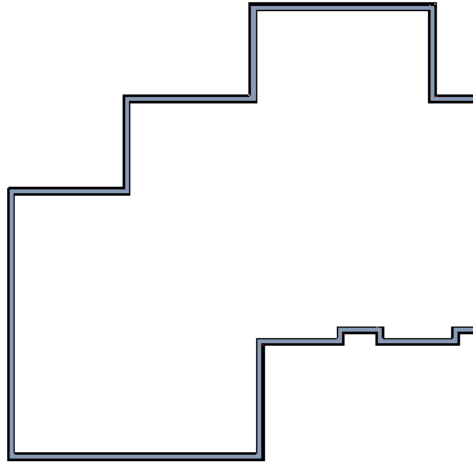



Interior walls are drawn the same way that exterior walls are.

*To draw interior walls*

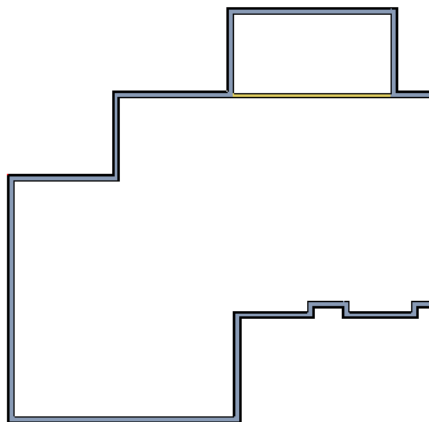
- Select **Build> Wall> Straight Interior Wall**  from the menu or click the corresponding toolbar button.
- Draw an interior wall as shown in the following image.



### *To delete a wall*

1. While the **Select Objects**  tool is active, click on a wall with the pointer to select it.
2. Press the **Delete** key or click the **Delete**  edit button.

---

## Creating Dimension Lines

Dimension lines locate walls, openings in walls, and other objects. In Home Designer Essentials, you can generate types of automatic dimension lines and draw a variety of manual dimensions. For more information, see “Dimensions” on page 342 of the Reference Manual.

### *To create automatic exterior dimension lines*

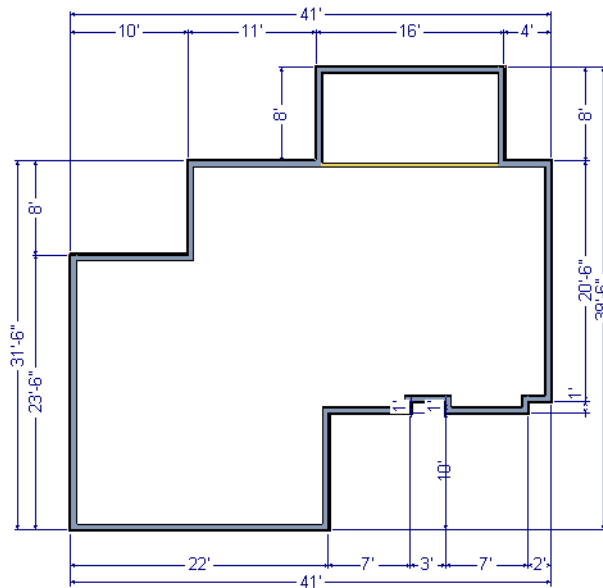

1. Select **CAD > Dimensions > Auto Exterior Dimensions** .



LIVING AREA  
1145 sq ft

2. For a closer view of a certain area, click the **Zoom**  tool, click and drag a box around the area you want to see in detail, and release the mouse button. That area fills the screen. For more information, see “Zoom & View Tools” on page 310 of the Reference Manual.





3. To return to the previous zoom factor, select **Window> Undo Zoom** .
4. If you can't see all the exterior dimension lines at once, select **Window> Fill Window Building Only**  to center your plan on screen.

---

## Adjusting Wall Positions

Now we'll adjust the spacing of walls with more precision. There are a couple of ways to move walls into position, but the fastest and most accurate uses dimension lines. For more information about using dimensions to relocate objects with accuracy, see "Moving Objects Using Dimensions" on page 350 of the Reference Manual.

### *To move walls using dimensions*

1. Let's begin by selecting **Window> Fill Window Building Only**  so we can see the entire building.
2. Click the **Select Objects**  button, then click on a wall that you want to move.
3. Click on a dimension line that indicates how far the selected wall is from another wall. There are a couple ways to determine which dimensions can be used for this purpose:
  - Move the selected wall and see which dimensions update.
  - Move your pointer over a dimension. If it is an associated dimension, the icon will change to a pointing hand ().

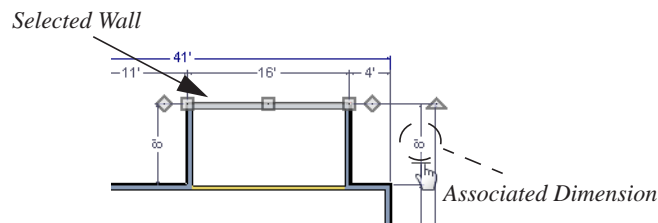

4. Click on the associated dimension and enter a new value. Remember, numbers entered with an apostrophe denote feet and numbers entered with quotes denote inches. If neither apostrophes or quotes are included, the entered value defaults to inches.
5. Use the Enter key on your keyboard to close the dialog and apply the change so that the wall will move the specified distance.
6. Repeat this process for the adjacent exterior wall, continuing in a clockwise direction. It may help to refresh **Auto Exterior Dimensions** (Shift + A) between commands.

 If you use dimensions to reposition walls, you should always work in the same direction, adjusting one wall section after another.

Dimensions can also be used to change the length of a selected wall. Bear in mind, though, that when a wall is resized in this manner its Start point will always be locked and its End point will always be moved. When, adjusting all the walls in a floor plan, it is often easier to move them than to resize them. See “Editing Walls” on page 107 of the Reference Manual.

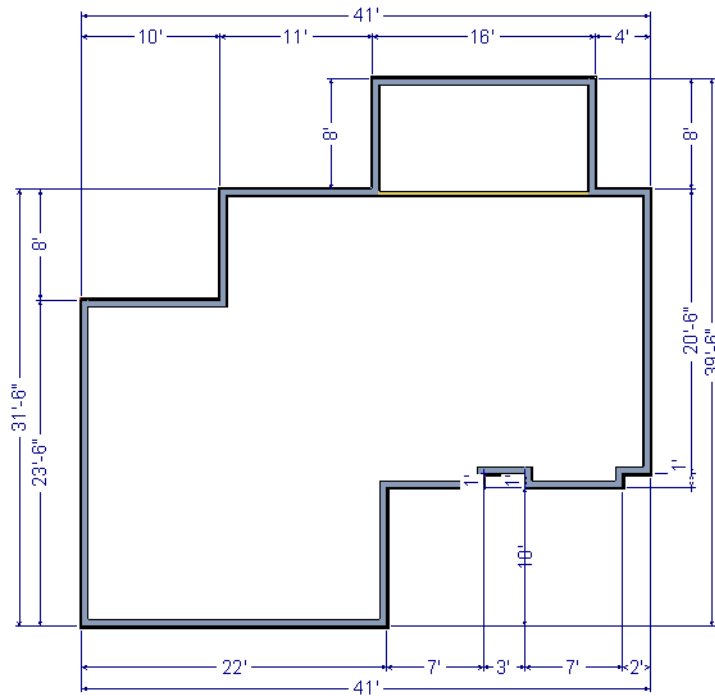

When you are finished, the dimensions of your model should match those in the following image.



When your exterior walls are positioned properly, you may find it helpful to delete the dimensions.

*To delete all dimensions at once*



1. Select **Edit > Delete Objects**  to open the **Delete Objects** dialog. See “Delete Objects Dialog” on page 93 of the Reference Manual.
2. Select the **All Rooms On This Floor** radio button.

- Check **Manual Dimensions** to delete manually-drawn dimension lines such as those drawn by the  tool;
- Check **Automatic Dimensions** to delete automatically generated dimension lines such as those created by the **Auto Exterior Dimensions**  tool;
- Click OK.

Although using dimensions is generally the fastest and most accurate way to move walls, you can also move them using their edit handles and edit tools.

#### *To move walls using their edit handle*

1. Click the **Select Objects**  tool then click on an exterior wall to select it.
2. Click and drag the Move edit handle that displays at the position along the wall where you clicked. Walls can be moved perpendicular to the direction that they are drawn.
3. As you move the wall, the dimension lines that indicate how far it is from other walls will update.

If you have difficulty positioning a wall at the desired location because it jumps over that location as you move it, try zooming in on it by scrolling with your mouse wheel or by using either the **Zoom**  or **Zoom In**  tool. You can also use the **Accurate Move**  edit tool to slow your mouse movement.

#### *To use the Accurate Move edit tool*

1. Click on the wall that you wish to move more slowly and with greater accuracy.
2. Click the **Accurate Move**  edit button.
3. Click and drag the Move edit handle to the desired position.

Your mouse will move more slowly for this edit only. The next time you want to move or resize the wall slowly, you will need to click the **Accurate Move**  edit button again.

---

## Creating Rooms

Now that the exterior of the house has been finalized we can begin laying out rooms on the interior. Rooms are defined by the walls that enclose them. They are then assigned a Room Type that assigns common room attributes. For more information about rooms, see “Room Types” on page 124 of the Reference Manual.

*To define rooms using interior walls*

1. Select **Build> Wall> Straight Interior Wall** , then click and drag to draw interior walls. As with exterior walls, you don't need to worry about exact placement as you draw.

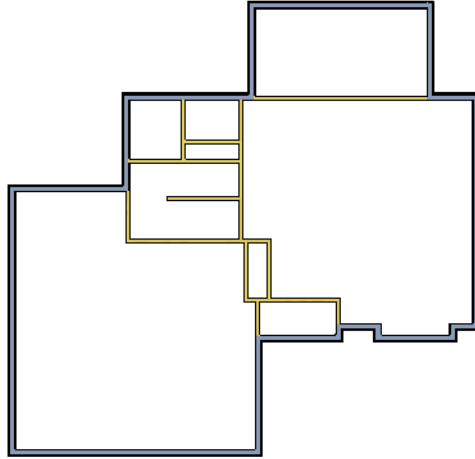

2. Select **Build> Wall> Break Wall**  and click to place two breaks at the locations shown in the following image.

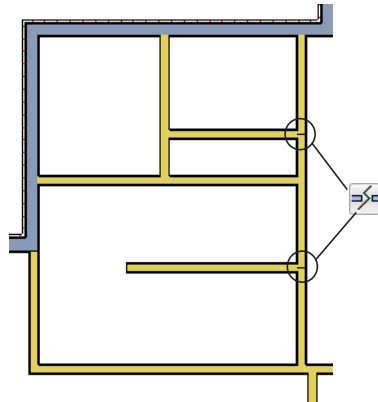

- Click the **Select Objects**  button, then select the top wall section created by the breaks and delete it. Repeat this process for the bottom wall section, so that only the middle section remains, which is hatched in the image below for illustrative purposes.

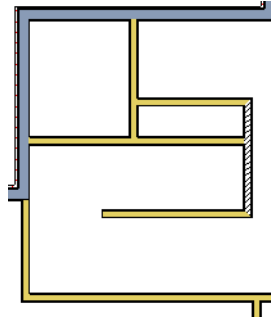

- Draw a horizontal **Manual Dimension**  inside this new room, then use it to move the vertical interior wall 9' 7 3/4" from the opposing exterior wall.

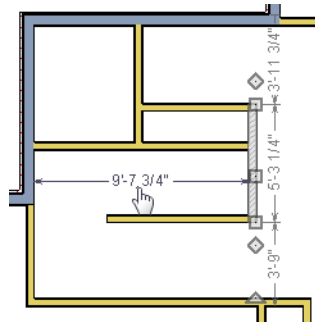

*To change a wall's type*

- Select a wall with the incorrect wall type and click the **Open Object**  edit button to open the **Wall Specification** dialog. See “Wall Specification Dialog” on page 114 of the Reference Manual.
- On the Wall Types tab, click the **Wall Type** drop-down list and select the desired wall type

3. Click **OK** to close the dialog and change the selected wall to the chosen wall type. Repeat this process for each of the wall's that you want to change, as in the image below.

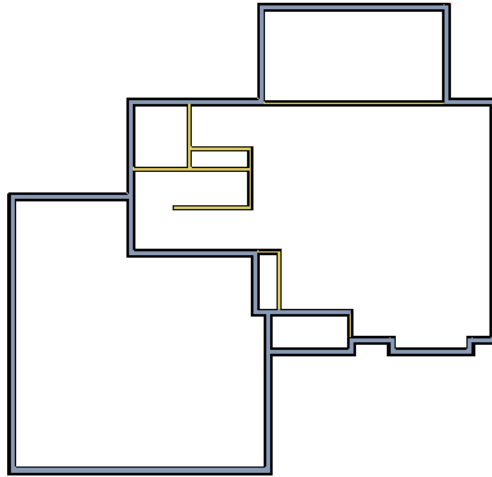

### Using Invisible Walls



In reality, rooms are not always divided by a physical wall. The separation of two rooms may be marked by a change in the flooring (carpet to tile, for example), or by a change in the interior wall covering. In Home Designer Essentials, an invisible wall can be used to define rooms without creating an actual wall. We'll use invisible walls to define more of the first floor layout.

As with changing a wall's type, we can also place a break and mark walls as Invisible, or draw walls using the tool. For more information, see "Invisible Walls" on page 101 of the Reference Manual.

*To create an invisible wall*

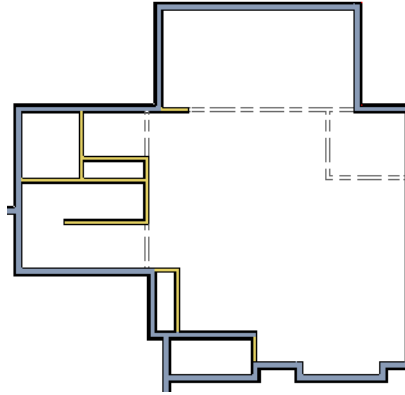
1. Select **Build> Wall> Invisible Wall**  and draw invisible walls as shown in the following image.



2. Using the **Select Objects**  tool, select one of the Invisible Walls and click on the **Open Object**  edit tool to display the **Wall Specification** dialog. On the **General** tab, note that **Invisible** and **No Locate** are checked.
3. Uncheck **No Locate**, as while this option is selected, it will prevent dimensions from locating the wall, and click **OK**. Repeat this process for any of the remaining invisible walls in the plan that you want to be able to dimension to.

- Adjust the wall spacing of the interior, exterior and invisible walls to match the following image using **Manual Dimensions** , just as you did with exterior walls.

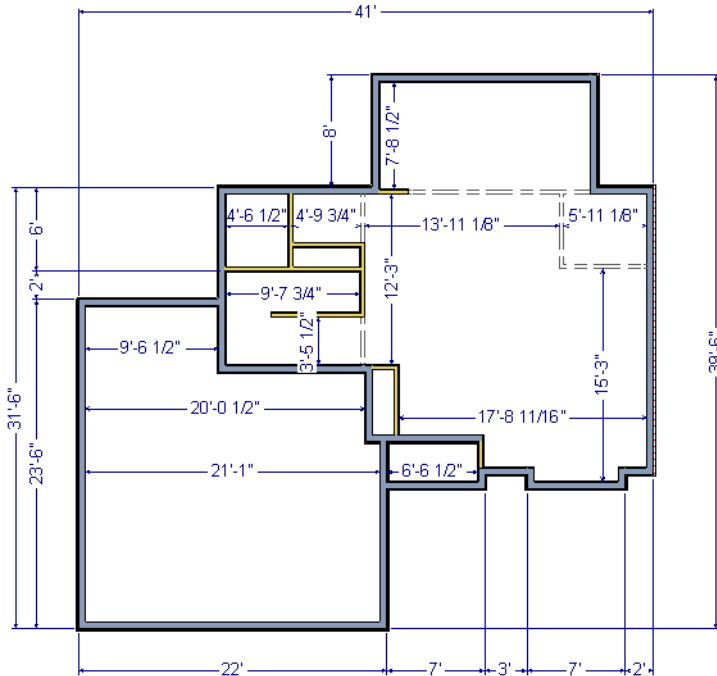

**LIVING AREA**  
1143 sq ft

## Room Types

Rooms in Home Designer Essentials are given special attributes by assigning a Room Type. For example, porches use a concrete floor material and have a ceiling and roof, while decks use floor planking and have no ceiling or roof. For more information, see “Rooms” on page 120 of the Reference Manual.

### *To designate a Room Type for a room*

- Click the **Select Objects**  button, then click in the small room at the bottom of the plan.



- Click the **Open Object**  edit button to open the **Room Specification** dialog.

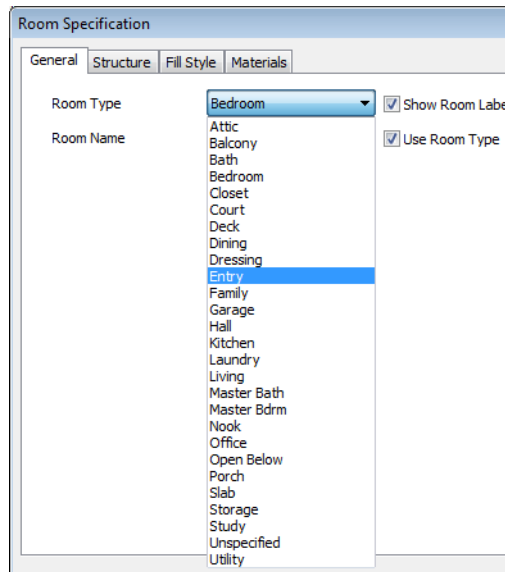

- On the General tab, click the **Room Type** drop-down list and select **Entry**.
- Click **OK** close the dialog and apply your change.

Double-clicking a room when the **Select Objects**  tool is active will also open the **Room Specification** dialog. For more information, see “Room Specification Dialog” on page 131 of the Reference Manual.

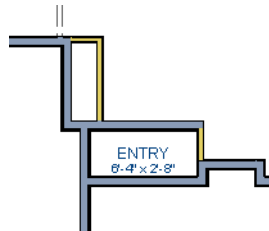

5. Open each of the rooms and assign room types as shown in the following image.

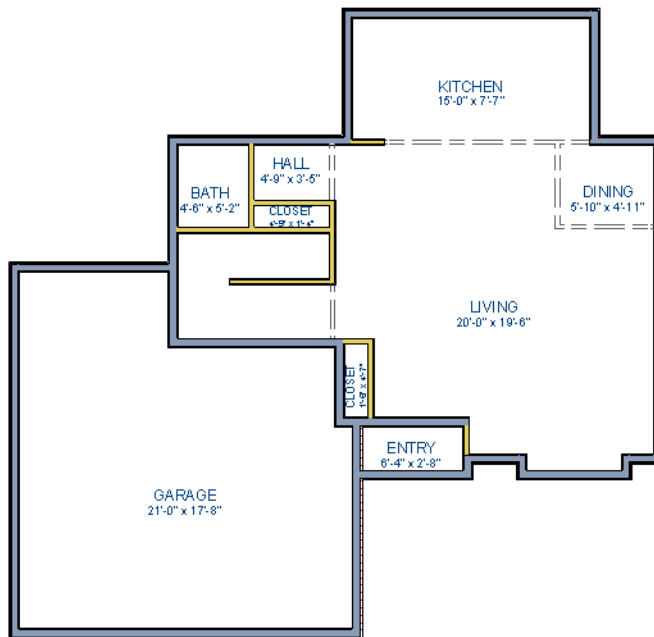

---

## Creating a 3D View

Let's take a look at our plan in 3D and see how it looks so far. For more information, see "3D Views" on page 318 of the Reference Manual.



### *To create a camera view*

1. In floor plan view, click the **Fill Window**  button to zoom out as needed to fill the view window with the entire drawing.
2. Select **3D > Create Camera View > Camera**  (or press Shift + J).

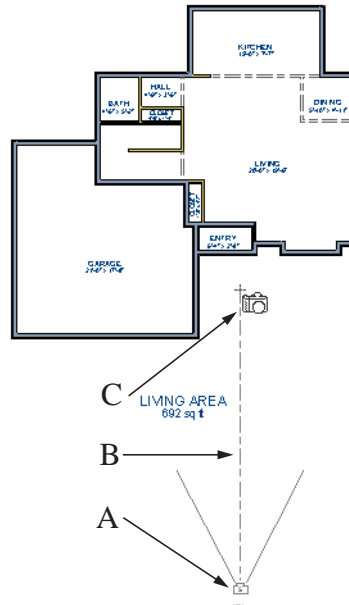
- Click at the bottom of the floor plan view window and drag a line that stops at the Entry. The point where you click (A) defines the point of perspective and the line (B) defines the direction of perspective.



- Release the mouse button to create the 3D camera view. Where the mouse is released (C) is the camera's focal point.
- If necessary, you can use the **Mouse-Orbit Camera**  tool to change the camera's perspective. The camera will revolve around its focal point (C). See "Repositioning Cameras" on page 325 of the Reference Manual for more information.

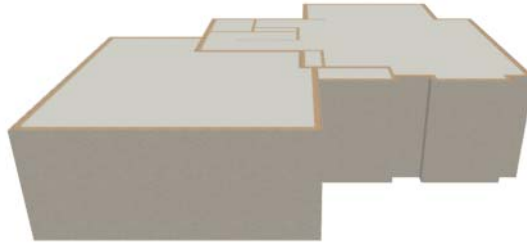

6. Once you have accurately positioned your camera, to smooth out the edges and create a more realistic rendering of the model, you can select **3D> Camera View Options> Final View**  or **Final View with Shadows** .



Final Views often take significantly longer to generate than Previews, so the 3D view reverts back to the Preview Settings as soon as anything is changed within the view.

7. To return to floor plan view, select **File> Close** from the menu.

#### *To create a Doll House View*

1. In floor plan view, select **3D> Create View> Doll House View** . A Doll House View displays a single floor without a ceiling or roof.
2. Select **3D> Move Camera With Mouse> Mouse-Orbit Camera**  (which should be selected by default) then click and drag the mouse on screen to change the camera perspective. You can press the I (in) and the O (out) keys on the keyboard to zoom in and

out of the plan. For more information on modifying camera views, see “Editing 3D Views” on page 328 of the Reference Manual.



---

## Adding Floors

Creating new floors in a plan is easy, but it is best to do so only after the first floor plan has been finalized. Now that we have done so in our plan, we’ll add a second story and basement. For more information about working with multiple floors, see “Multiple Floors” on page 170 of the Reference Manual.

### *To add a second floor*

1. Select **Build> Floor> Build New Floor** . The **New Floor** dialog displays.
2. Select **Derive new 2nd floor plan from the 1st floor plan** and click **OK** to close the **New Floor** dialog to display the Floor 2 Defaults.
3. Click **OK** and a floor plan for the second floor is created based on the exterior walls of the first floor plan. We will need to edit the walls of our second floor manually. It will be difficult to know where the second story walls should be without knowing where the first floor walls are located.

4. Select **Tools > Reference Floors > Reference Display**  (or press F9). The first floor walls are displayed for reference.

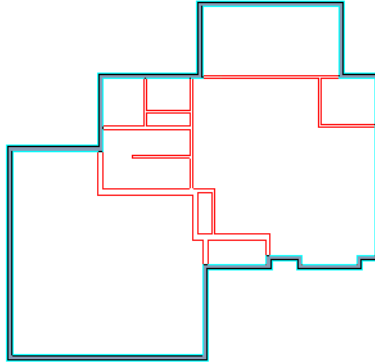

We will now edit the second story walls.

***To merge two parallel walls into one***

1. Select the upper wall of the house, then click and drag its center edit handle to move it.
2. When the wall becomes aligned with another wall and can merge with it, it will stop at a "sticky point."
3. If you keep dragging the mouse, the wall will break free of the sticky point and you can continue moving it. In this case, we will release the mouse button.

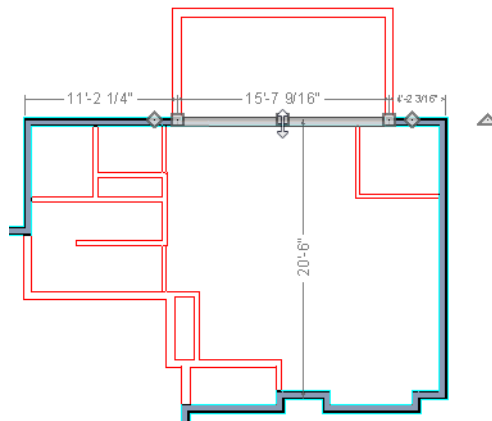

- Note that if select the wall now, the edit handles now extend the full length of the wall.

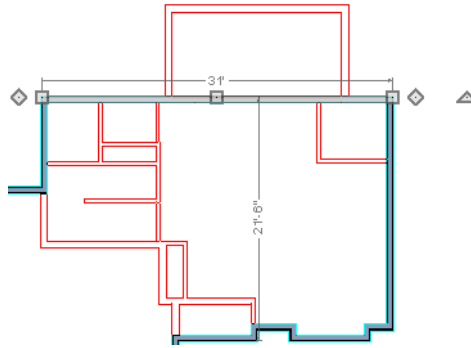

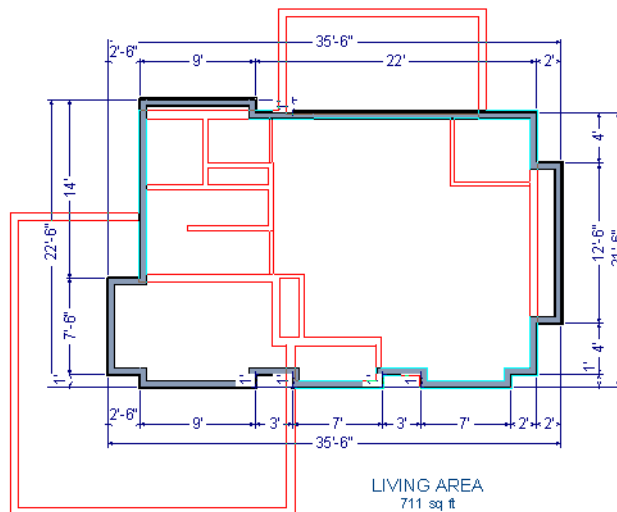

Note: Before merging walls, make sure Object Snaps are turned on. For more information, see “Object Snaps” on page 63 of the Reference Manual.

- Repeat these steps until we have exterior walls that are aligned as shown in the following image. To achieve this, we could also have created a blank second floor plan and then drawn our second story walls manually.



- At this point, let's remember to **Save**  our plan before adding a foundation level.

*To create a foundation or basement*

1. Select **Build> Floor> Build Foundation** . In the **Build Foundation** dialog:
  - Change the **Wall Height** to 100 inches.
  - Click **OK** to close the dialog and create a foundation level for your plan.
2. Select **Derive New Foundation Plan From the First Floor Plan** and click **OK** to close the **New Floor** dialog. For more information, see “Adding Floors” on page 172 of the Reference Manual.
3. You can select **Window> Fill Window Building Only**  from the menu to center the plan on screen.

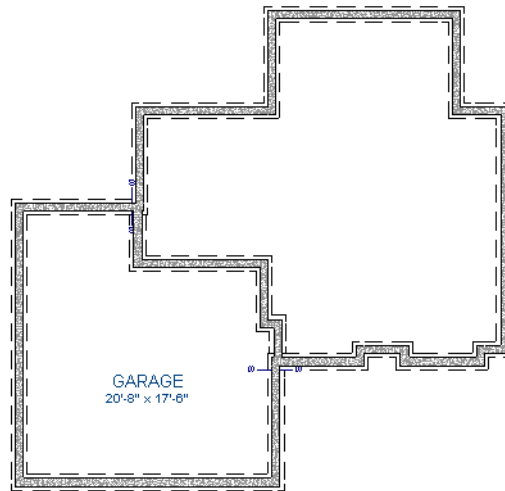

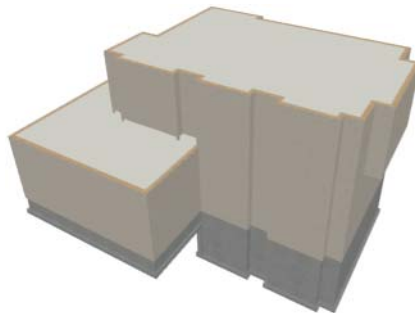

4. Select **3D> Create View> Full Overview**  from the menu to create a 3D overview of our entire plan so far.





### *To add a second story balcony*

Now that we have a second floor, we'll use the tools and techniques we learned earlier to add a second story balcony that is aligned with the floor below.





1. Press **Ctrl + Tab** on your keyboard to switch back to floor plan view and return to Floor 2.
2. If they are not already displayed, click **Reference Display**  to display the first floor walls.
3. Select **Build> Wall> Straight Railing** .

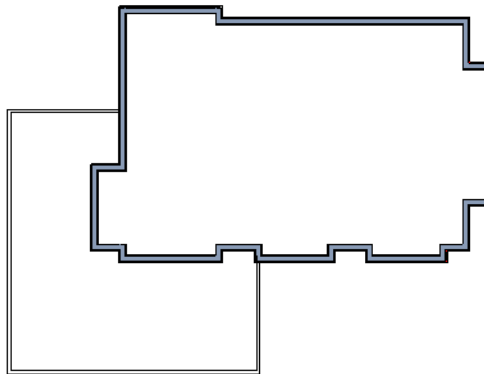

For best results, do not use the Deck Railing tool or specify the balcony room as a Deck.

4. Draw a balcony as shown in the following image. You can manually align the wall with the first floor deck below in the following steps.



5. Next, use the **Select Objects**  tool to select one of the railings, and click on the **Open Object**  edit tool to display the **Railing Specification** dialog. On the General tab, increase the Thickness to 8 1/8" then click **OK**.
6. Repeat this process for the remaining railings in the plan.
7. Select a section of railing that has a wall below it on the first floor and click the **Align with Wall Below**  edit button.
  - Note: If **Align with Wall Below**  is not available, the selected railing either needs to be moved closer to the wall below, or the railing is already aligned with the one below. See "Aligning Walls" on page 110 of the Reference Manual.

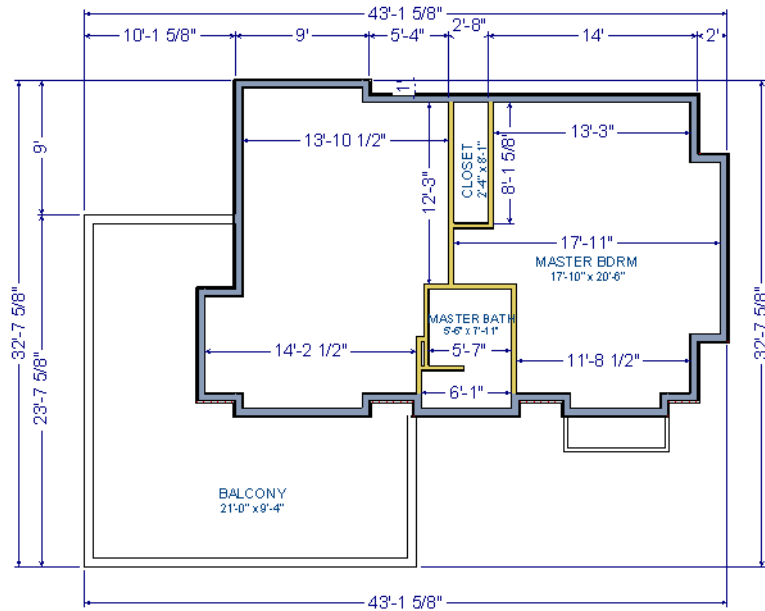

8. Repeat this step for each section of railing that has a railing directly below it on the first floor.
9. Finally, you can customize the interior of your second floor with interior walls. When you are finished, your second floor should look similar to this:



## Adding Stairs

Now that we've got three floors we'll need to get from one floor to another. For more information about stairs, see "The Stair Tools" on page 205 of the Reference Manual.

### *To draw stairs with a landing*

1. Click **Down One Floor**  to go to the first floor. You may want to select **Tools> Reference Floors> Reference Display**  to turn off the display of the reference floor.
2. Select **Build> Stairs> Straight Stairs**  (or press Shift + Y).

- Click and drag to draw a short stair section as shown in the following image.

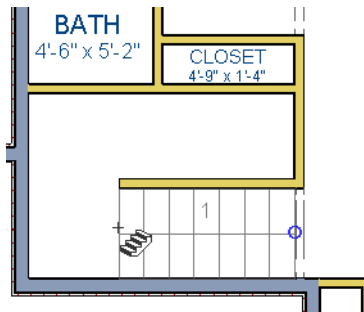

- Draw another stair section 180° to the right of the first stair section, along the interior wall.

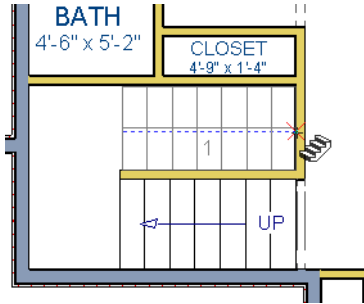

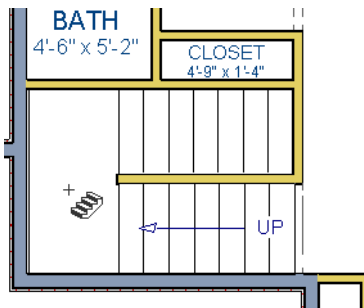

- While the **Straight Stairs**  tool is still active, click in between the two stair sections to create a landing.



- Click on the landing with either the **Straight Stairs**  or **Select Objects**  tool active, and if needed, resize it using its edit handles to fit against the wall.

*To create a stairwell*

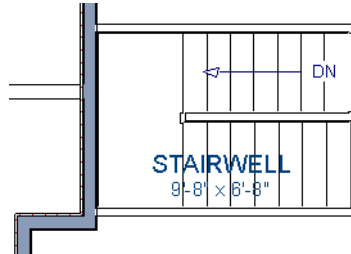

1. Select either of the two stair sections.
2. Click the **Auto Stairwell**  edit button to create a stairwell.
3. Click the **Up One Floor**  button to go to the second floor. Notice that the second floor now displays a stairwell defined by railings.



A stairwell is an interior room that is automatically assigned the **Room Type** “Open Below” in the **Room Specification** dialog. See “Room Specification Dialog” on page 131 of the Reference Manual.



It makes sense to draw the basement stairs directly below the stairs to Floor 1. We could use the **Auto Stairwell**  edit tool to create another stairwell; however, in this situation, it will be better to use our existing interior walls to define the stairwell, rather than by the railings that the Auto Stairwell tool generates.

*To manually create a stairwell*

1. Click the **Down One Floor**  button to go down to Floor 1.
2. Next, click on a stair section inside of the stairwell room and click the **Select Next Object**  edit button as many times as needed until the room is selected instead of the stair.

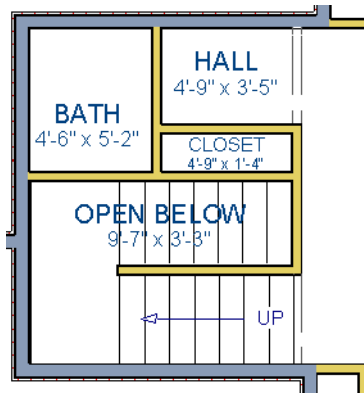

- With the room selected, click the **Open Object**  edit button and in the **Room Specification** dialog, select Open Below from the **Room Type** drop-down list and click OK.



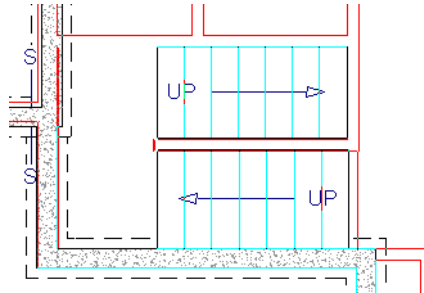



- Go **Down One Floor**  to the foundation (Floor 0) level, and turn on the **Reference Display** .
- Select **Build> Stairs> Straight Stairs**  and draw two stair sections directly below the stairs you drew on Floor 1. Do not draw the landing just yet, though.

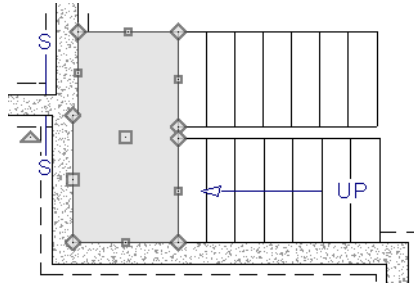

- Select each stair section and adjust its width and position using its edit handles so that it fits within the walls forming the stairwell drawn on Floor 1.
- When the stair sections are positioned properly, click with the **Straight Stairs**  tool to create a landing as you did on Floor 1.

- Next, use the **Select Objects**  tool to select the landing, click on the **Break Line**  edit tool, and click along the landing's edge to place a break, which allows you to reshape it so that it fits against the foundation walls.



- Select **3D> Create View> Full Overview** .
- When the view has generated, select **3D> Glass House**  to view our entire model, inside and out.
- Select **3D> Move Camera With Mouse> Mouse-Orbit Camera**  and click and drag the mouse on screen to change the camera perspective. You can press the I (in) and the O (out) keys on the keyboard to zoom in and out of the plan.

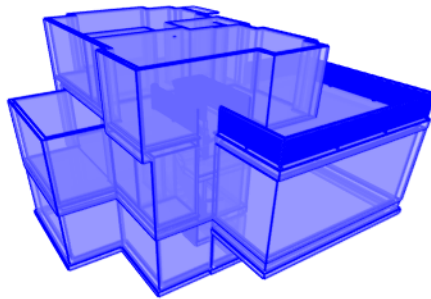

---

## Placing Doors and Windows

We're making progress on our house, but we can't get into it, and neither can light. Now is a good time to add some doors and windows. For more information about doors and windows, see "Doors" on page 138 of the Reference Manual and "Windows" on page 154 of the Reference Manual.



**To add a door**

1. If your views are still tiled, close the 3D view and maximize the floor plan view.
2. Select **Build> Door> Hinged Door** .
3. Move the pointer to the entry and click on the front wall, left of its center, to place a door.

**To add a window**

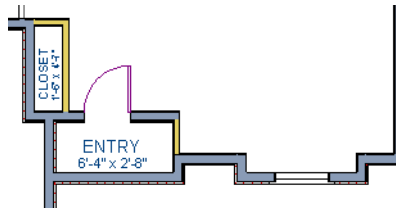
1. Select **Build> Window> Window** .
2. Move the pointer to the entry and click on the wall, right of center, to place a window.

**To edit a door**

1. So that we can better see the results when we edit our door, let's select **3D> Create Camera View> Perspective Full Camera**  to create a camera view of the entry. Click and drag a camera arrow inside the structure, pointed at the entry.
2. Click the **Select Objects**  tool, then click on the door to select it in the 3D view.



3. Click the **Open Object**  edit button to open the **Door Specification** dialog. For more information, see “Door Specification Dialog” on page 147 of the Reference Manual.

4. On the General tab, set the **Door Style** to Glass and set the Width to 36".
5. On the Frame & Lites tab, set the **Frame Bottom** to 8 inches. Press the Tab key to update the preview image on the right side of the dialog so that it reflects your change.
6. On the Lites tab, set the **Lites across** to 3 and **Lites vertical** to 5.
7. On the Hardware Tab, set the Handle **In from Door Edge** to 2"
8. Click **OK** to return to the 3D view.



*To edit a window*

1. Next, click on the window to select it.





2. Click the **Open Object**  edit button to open the **Window Specification** dialog. For more information, see “Window Specification Dialog” on page 164 of the Reference Manual.
3. On the General tab, select “Fixed Glass” from the **Window Type** drop-down list and set the **Width** to 54”.
4. On the Lites tab, change the **Lites across** to 4 and **Lites vertical** to 4.
5. Click OK to close the **Window Specification** dialog.



If you would like all of your doors and/or windows to be customized, make your changes in the Door Defaults and Window Defaults dialogs before placing these objects. For more information, see “Default Settings vs Preferences” on page 47 of the Reference Manual.

### *To change the door swing*

1. Return to floor plan view and select the door.

2. Click the **Change Opening/Hinge Side**  edit button.

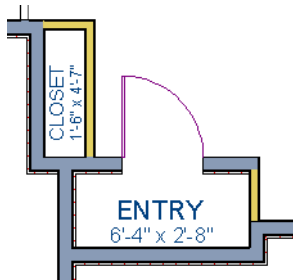



#### *To copy a window or door*

1. Return to the 3D view and select the window, or door, you wish to copy.
2. Click the **Copy/Paste**  edit button. For more information about copying objects, see “Copying and Pasting Objects” on page 66 of the Reference Manual.

Doors and windows can be placed, selected, deleted, copied, pasted, and edited in either 2D or 3D views. If there is a window design that you will be using throughout a plan, you can create it once, then just copy and paste it. An even better approach is to set your door and window defaults to the desired settings before placing these objects. For more information, see “Default Settings vs Preferences” on page 47 of the Reference Manual.

#### *To create a doorway*

1. Return to floor plan view and **Zoom**  in on the entry room.
2. Select **Build> Door> Doorway**  and click on front Entry room wall nearest to place a doorway.
3. Select **3D> Create View> Camera**  and create an exterior camera view of the doorway.

#### *To customize the doorway*

1. Select the doorway by clicking on its frame and click the **Open Object**  edit button to open the **Door Specification** dialog.
2. On the General tab, change the **Width** to 54" and the **Height** to 96".
3. On the Casing tab, change the **Casing Width** to 10". Be sure to delete the (D) from the text field as it stands for "default" and will continue to apply the default casing width if it is not removed, regardless of the value you specify.
4. Click OK to close the **Door Specification** dialog.

***To center a wall opening***

1. Return to floor plan view and select the doorway.
2. Click the **Center Object**  edit button, then click inside the entry room, near the interior wall containing the doorway. For more information, see “Using Center Object” on page 90 of the Reference Manual.

Use the tools and techniques you’ve learned to add window and doors to the rest of the plan, as shown in the following images. Doors placed in interior walls become interior doors and have different specifications than exterior doors. If you feel inspired, customize the doors and windows as you see fit. For example, increase a door’s width to 48” or greater and the program will automatically create a double door.

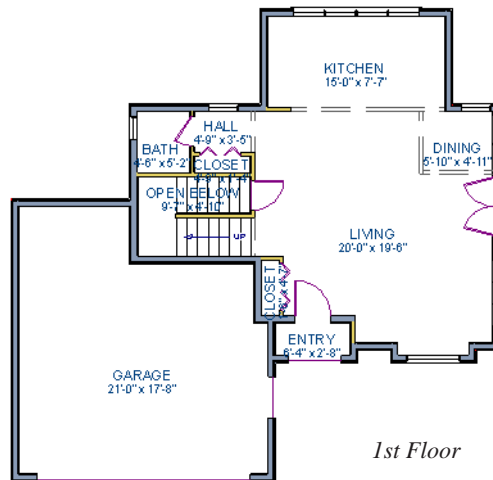

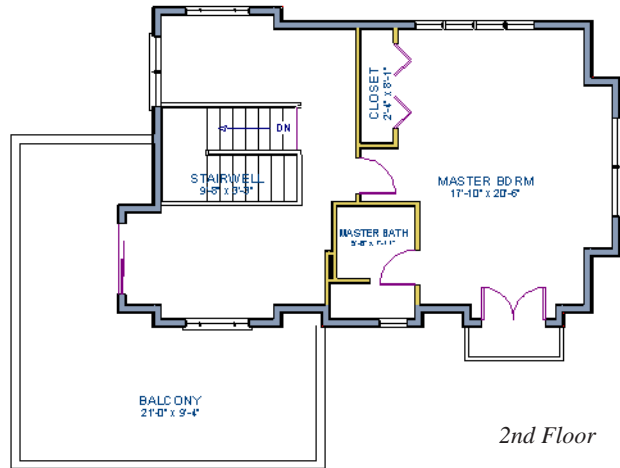

When you have finished, **Save**  your work.

If you would like, you can continue working on this plan in the Interior Design Tutorial or Kitchen and Bath Design Tutorial. You can also learn about materials in the Materials Tutorial or find out more about roofs in the Roof Tutorial.

# Roof Tutorial

The first portion of this tutorial can be completed independent of the previous tutorials. We'll go over some common roof styles that can be created using settings in the **Wall Specification** dialog. We'll also learn how to add gables over doors and windows, how to create dormers automatically and manually, and how to create skylights. For additional information about using the Roof Tools, see "Roofs" on page 190 of the Reference Manual.

In this tutorial you'll learn about:



- Deleting Roofs
- Hip Roofs
- Gable Roofs
- Shed Roofs
- Saltbox Roofs
- Gambrel Roofs
- Gull Wing Roofs
- Half Hip Roofs
- Mansard Roofs
- Roof Type Quick Reference
- Adding Gables over Doors and Windows
- Manually Drawn Dormers
- Skylights
- Using the Break Wall Tool to Modify Roofs
- Troubleshooting Roof Issues

---

## Getting Started with Roofs

To gain a basic understanding of roofs and how they function with Home Designer Essentials, we'll begin this section of the tutorial with a new plan.

*To begin a new plan*

1. If any plans are open, select **File> Close All** from the menu.
2. Select **File> New Plan**  to open a new plan. In the **Create New Plan** dialog, select the Default Style template.
3. Select **Build> Wall> Straight Exterior Wall**  and draw a rectangular floor plan, measuring about 34 feet by 24 feet (approximately 10.4 m by 7.3 m), in a clockwise direction. We'll use this outline to build a number of different roof styles. See "Drawing Walls" on page 103.

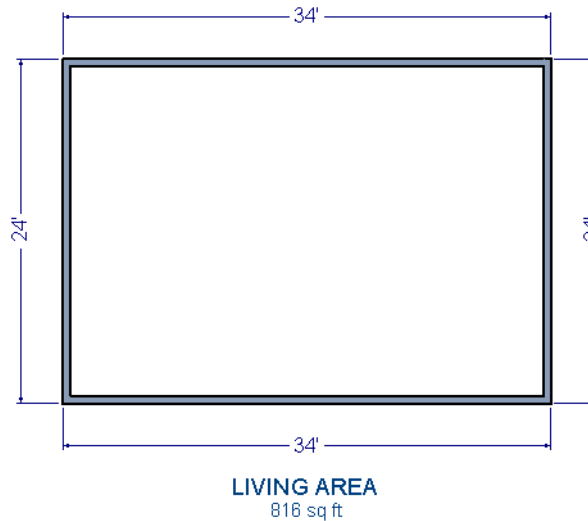

---

## Deleting Roofs

Roof planes can be easily deleted in either of two ways.

*To delete a roof*

1. Select **Build> Roof> Delete Roof** .
- Select **Edit> Delete Objects**  and in the **Delete Objects** dialog, select **All Rooms On This Floor**; place a check beside **Roof**; and click **OK**.



## Hip Roofs

When roofs are automatically generated, the default roof type is a hip roof, which means that a roof plane is built over every exterior wall in the plan that does not have another wall drawn above it.

### *To create a hip roof*

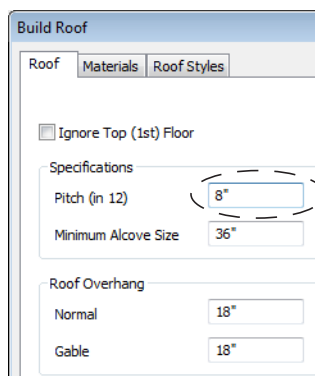
1. Select **Build> Roof> Build Roof**  from the menu to open the **Build Roof** dialog. The **Pitch** is set at 8 in 12 inches.



2. Click **OK** to generate a hip roof.
3. Select **3D> Create > Overview**  to create a 3D overview of the house. If you wish, you can select **3D> Toggle Textures**  from the menu to turn off the display of textures.
4. Select **Window> Tile Vertically**  to see both views at the same time.

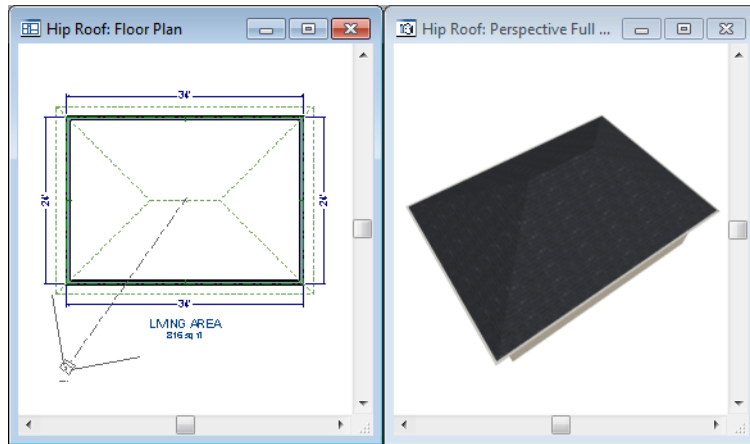



---

## Gable Roofs

If you would like a gable over a particular wall rather than a roof plane bearing on it, you can specify it as a **Full Gable Wall** in the **Wall Specification** dialog.



To create a gable over a wall, specify it as a **Full Gable Wall**. To create basic gable roof, two walls must be specified as such.

### *To create a gable roof*

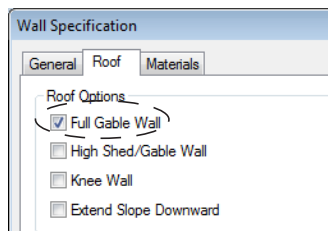
1. Click on the floor plan view window to make it the active view.
2. Select **Build > Roof > Delete Roof** .
3. Use the **Select Objects**  tool to select one of the walls drawn vertically on screen.
4. Click the **Open Object**  edit button and on the Roof tab of the **Wall Specification** dialog, check **Full Gable Wall** and click OK.





- Alternatively, you can click the **Change to Gable Wall(s)**  edit button.
  - To remove the Full Gable Wall attribute from a wall, you can select it and click the **Change to Hip Wall(s)**  edit button.
5. Modify the other vertically-drawn wall in the same manner.
  6. Select **Build> Roof> Build Roof**  to open the **Build Roof** dialog and click **OK**.

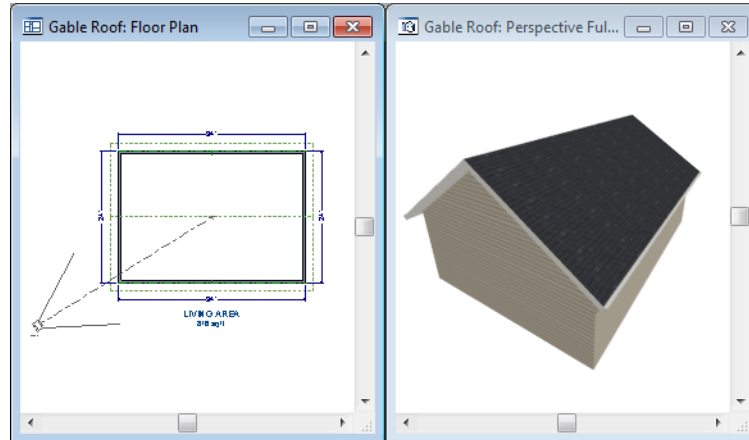

### Attic Walls

When a roof is generated, attic walls are also generated. An attic wall fills the space between the first floor walls and angled roof planes above. To see this in floor plan view, take a look at the second floor.

If you do not want to see attic walls in floor plan view, you turn off their display.

#### *To turn off the display of attic walls*



1. In floor plan view, select **Tools> Display Settings> Display Options**  (or press the ~ key) to open the **Display Options** dialog.
2. Find Walls, Attic in the Name column, remove the check from the Disp column for this item, and click OK. For more information, see “Display Options Dialog” on page 60 of the Reference Manual.

---

## Shed Roofs

To create a single, sloping roof plane, or shed roof, two walls must be specified as **Full Gable Walls**, and one must be a **High Shed/Gable Wall**.

*To create a shed roof*

1. Click on the floor plan view window to make it the active view.
2. Select **Build> Roof> Delete Roof** .
3. With the **Select Objects**  tool, double-click the lower horizontal wall and on the Roof tab of the **Wall Specification** dialog, check **High Shed/Gable Wall** and click OK.
4. As in the Gable Roof example, specify the left and right vertical walls as **Full Gable Walls**.
5. Select **Build> Roof> Build Roof**  to open the **Build Roof** dialog and click **OK**.

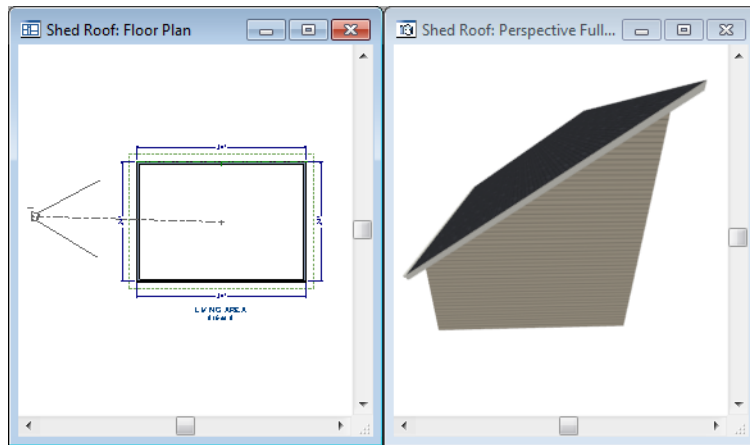



---

## Saltbox Roofs

A saltbox is a type of gable roof with different pitches on each of the two roof planes and an offset ridge. Assign a different pitch to the two roof planes in the **Wall Specification** dialog for the wall supporting each one.

*To create a saltbox roof*

1. Click on the floor plan view window to make it the active view.
2. Select **Build> Roof> Delete Roof** .
3. With the **Select Objects**  tool, double-click the lower horizontal wall. On the Roof tab of the **Wall Specification** dialog, remove the check from **High Shed/Gable Wall** and change the pitch to 12 in 12. Click OK to close the **Wall Specification** dialog.

4. Leave the **Full Gable Wall** box checked for the two vertical walls.
5. Select **Build> Roof> Build Roof**  to open the **Build Roof** dialog, specify the pitch as 3 in 12, and click **OK**.

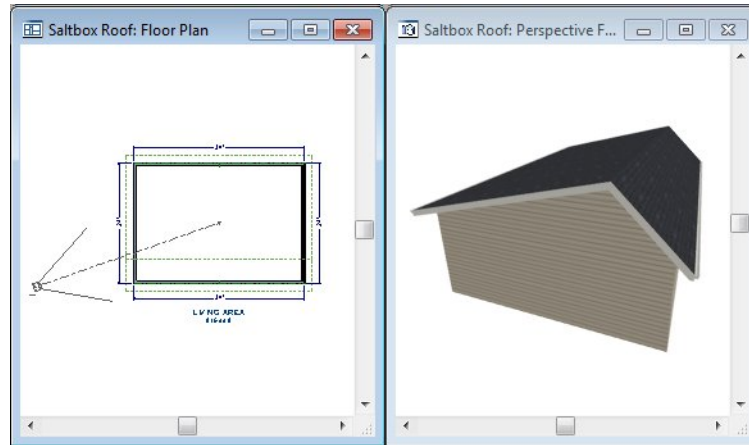

## Gambrel Roofs

A gambrel or barn style roof has two pitches on each side of the ridge. The first (lower) pitch on either side is steeper than the pitch near the ridge.

### *To create a gambrel roof*

1. Click on the floor plan view window to make it the active view.
2. Select **Build> Roof> Delete Roof** .
3. Select the horizontal walls and open them for specification. On the Roof tab:

Pitch Options

Pitch  in 12

Upper Pitch

Pitch  in 12

Starts at Height

In from Baseline

- Specify the lower **Pitch** as 12 in 12.
- Place a check in the box beside **Upper Pitch**.

- Keep the **Upper Pitch** as 6 in 12 and change the **Start Height** to 156.
4. Click OK to close the **Wall Specification** dialog.
  5. The two vertical walls should remain Full Gable Walls.
  6. Open the **Build Roof** dialog, specify the **Pitch** as 6 in 12 once again, and click **OK**.

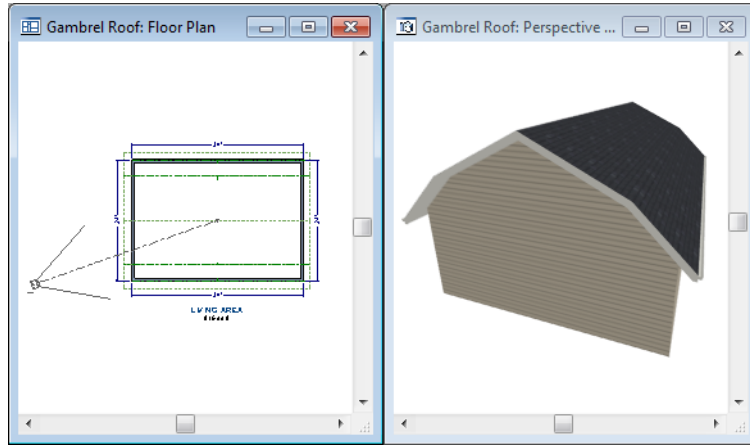

Experiment with alternate pitches and overhangs. Also, try varying the height at which the second pitch begins so that you can see the effect it has on your gambrel roof design.

---

## Gull Wing Roofs

A gull wing roof has two pitches on either side of the ridge, as a gambrel does; but the first pitch of a gull wing is shallower than the second.

### *To create a gull wing roof*

1. Click on the floor plan view window to make it the active view.
2. Select **Build> Roof> Delete Roof** .
3. Change the following settings for each of the horizontal walls on the Roof tab of the **Wall Specification** dialog:

Pitch Options

Pitch  in 12

Upper Pitch

Pitch  in 12

Starts at Height

In from Baseline

- Specify the lower **Pitch** as 3 in 12.
  - Place a check in the box beside **Upper Pitch**.
  - Keep the **Upper Pitch** as 12 in 12 and change the **Start Height** to 125".
4. The two vertical walls remain Full Gable Walls.
  5. Click the **Build Roof**  tool and click **OK** in the **Build Roof** dialog.

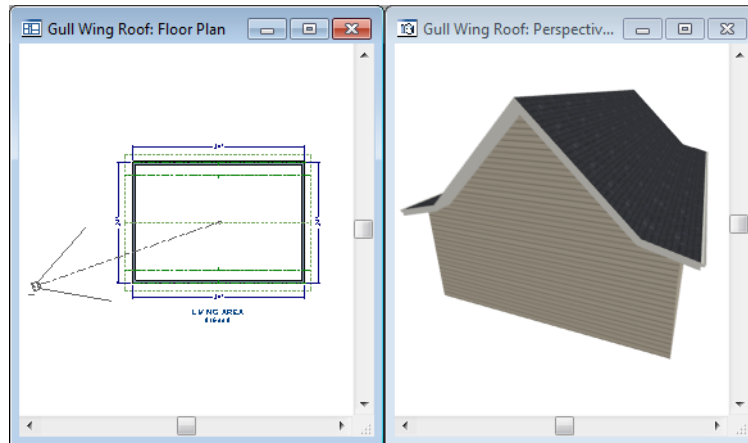

Experiment with the height at which the second pitch begins so that you can see the effect it has on your gull wing roof design.

---

## Half Hip Roofs

A half hip roof has two gable ends. At the top of each gable is a small hip that extends to the ridge.

### *To create a half hip roof*

1. Click on the floor plan view window to make it the active view.
2. Select **Build> Roof> Delete Roof** .

3. With the **Select Objects**  tool, double-click each wall and make these changes on the Roof tab of the **Wall Specification** dialog:

For the two Horizontal walls:

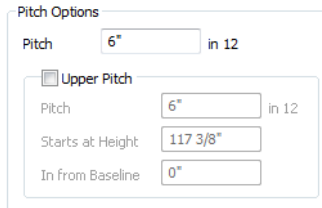

- Specify the lower **Pitch** as 6 in 12.
- Uncheck the box beside **Upper Pitch**.

For the two Vertical walls:

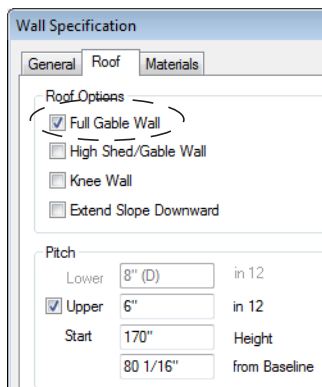

- Leave the **Full Gable Wall** box checked.
- Check the box beside **Upper Pitch**.
- Specify the **Upper Pitch** as 3 in 12 and set the **Start Height** at 170".

4. Click the **Build Roof**  tool and click **OK** in the **Build Roof** dialog.

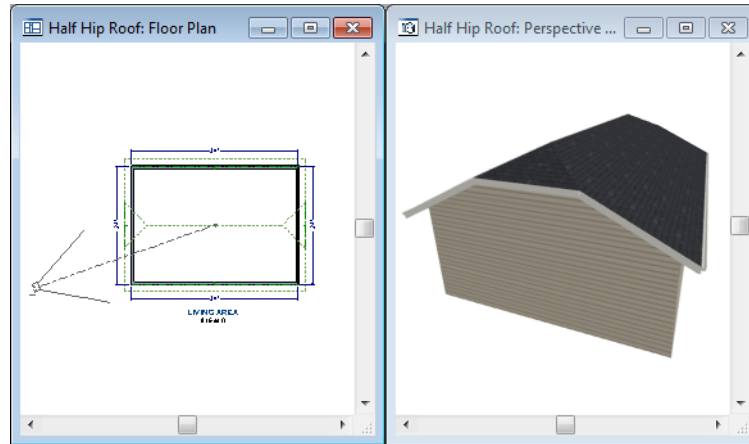



---

## Mansard Roofs

A mansard roof is a hip roof with two slopes on the roof sections above each of the four walls. The second slope begins at the same height above each wall. The upper slope is usually quite gentle and the lower slope, much steeper.

### *To create a mansard roof*

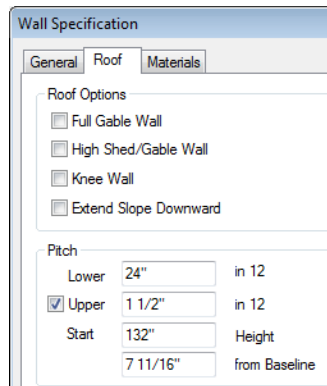
1. Click on the floor plan view window to make it the active view.
2. Select **Build> Roof> Delete Roof** .
3. Select all four walls, open them for specification, and on the Roof tab of the **Wall Specification** dialog specify the following settings:



- Clear the **Full Gable Wall** checkbox.
  - Specify the lower **Pitch** as 24 in 12.
  - Place a check in the box beside **Upper Pitch**.
  - Keep the **Upper Pitch** as 1.5 in 12 and change the **Start Height** to 132".
4. Click the **Build Roof**  tool and click **OK** in the **Build Roof** dialog.

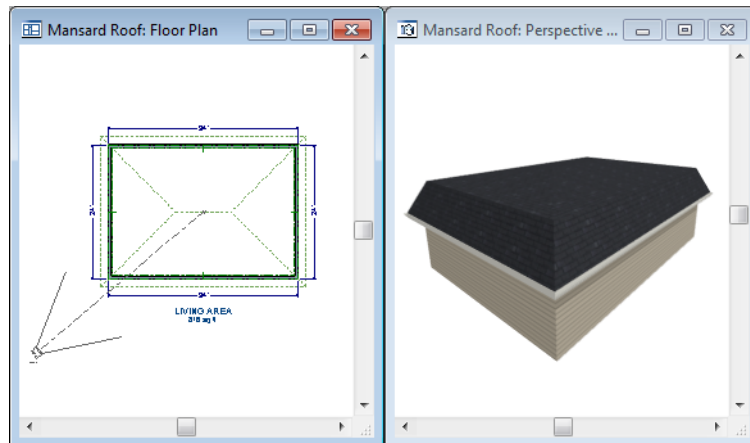



## Roof Type Quick Reference



The following chart provides a quick reference for building the roof styles described in this tutorial. The chart shows which walls to change and what to change on the Roof tab of the **Wall Specification** dialog for each wall. These parameters are based on a 34x24-foot model. For different size plans, adjust these numbers.

Roof Type	Wall to Change	Set as Full Gable	Set as High Shed Gable	Lower Pitch	Upper Pitch	Start Height
Gable Roof	Vertical Wall 1					
	Vertical Wall 2					
	Horizontal Wall 1	X				
	Horizontal Wall 2	X				
Shed Roof	Vertical Wall 1	X				
	Vertical Wall 2	X				
	Horizontal Wall 1		X			
	Horizontal Wall 2					
Saltbox Roof	Vertical Wall 1	X				
	Vertical Wall 2	X				
	Horizontal Wall 1			12 in 12		
	Horizontal Wall 2			3 in 12		
Gambrel Roof	Vertical Wall 1	X				
	Vertical Wall 2	X				
	Horizontal Wall 1			12 in 12	6 in 12	156
	Horizontal Wall 2			12 in 12	6 in 12	156
Gull Wing Roof	Vertical Wall 1	X				
	Vertical Wall 2	X				
	Horizontal Wall 1			3 in 12	12 in 12	125
	Horizontal Wall 2			3 in 12	12 in 12	125
Half Hip Roof	Vertical Wall 1	X			3 in 12	170
	Vertical Wall 2	X			3 in 12	170
	Horizontal Wall 1			6 in 12		
	Horizontal Wall 2			6 in 12		
Mansard Roof	Vertical Wall 1			12 in 12	1.5 in 12	132
	Vertical Wall 2			12 in 12	1.5 in 12	132
	Horizontal Wall 1			12 in 12	1.5 in 12	132
	Horizontal Wall 2			12 in 12	1.5 in 12	132



## Adding Gables over Doors and Windows

You can add a gable roof over a door or window.



### *To create a gable roof over a door or window*

1. Select a door or window, then click the **Gable Over Door/Window**  edit button.
2. Click the **Build Roof**  tool and click **OK** in the **Build Roof** dialog.
3. A gable is created with an overhang of one foot on each side of the door or window.

### *To remove a gable roof over a door or window*

1. Select the door or window and click the **Delete Gable Over Opening**  edit button.
2. Click the **Build Roof**  tool and click **OK** in the **Build Roof** dialog.
3. When you rebuild the roof, the gable will be removed.

### *To create a gable over several doors and/or windows*

1. Select a door, window, or mulled unit.
1. Hold down the Shift key and click on additional doors and/or windows to add them to your selection set.
2. Click the **Gable Over Door/Window**  edit button.
3. Click the **Build Roof**  tool and click **OK** in the **Build Roof** dialog to create a gable over the selected wall openings.





## Manually Drawn Dormers

To create dormers in an upper floor, create a new floor for your plan and modify this floor with knee walls and windows to form gables. We'll start with a new 40 x 30 foot plan to learn this technique.



As with automatic dormers, roof pitches of 9 in 12 or greater generally work better than shallow pitches when creating dormers because they provide enough vertical space to build the dormer within.

### *To create a new plan*

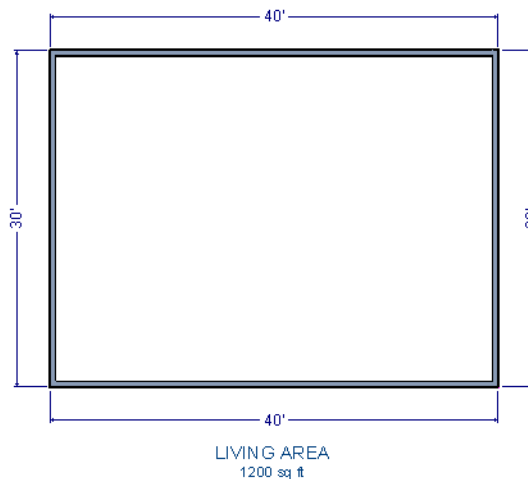
1. Select **File> Close All** from the menu to close any open plans.
2. Select **File> New Plan**  to open a new plan. In the **Create New Plan** dialog, select the Default Style template.
3. Select **Build> Wall> Straight Exterior Wall**  and draw a rectangular floor plan, 40 feet by 30 feet, in a clockwise direction.
4. Click the **Fill Window Building Only**  button to zoom in on the house.



5. Select **File> Save**  from the menu, save the file to an easy to find location, such as Documents, and give the plan a name.
6. Select the right and left vertical walls, open them for specification, and on the Roof tab of the **Wall Specification** dialog, click the **Full Gable Wall** check box and click OK.

7. Select **Build> Floor> Build New Floor** .
8. Check the **Derive new 2nd floor plan from 1st floor plan** option in the **New Floor** dialog and click OK to display the Floor 2 Defaults dialog. Leave these settings at their default for now and click OK.
9. Select **Build> Roof> Build Roof** , change the pitch to 12 in 12, and click **OK** in the **Build Roof** dialog.

*To create two knee walls*

A knee wall is a short wall on an upper floor that is cut off by a roof plane.

1. Select **Build> Wall> Straight Interior Wall**  and draw a horizontal interior wall (from left to right). Position this knee wall so that it is 5 feet from the top exterior wall.
2. Draw another interior wall (from right to left) and position it 5 feet from the bottom exterior wall. You can reposition the knee walls using dimensions. For more information, see “Moving Objects Using Dimensions” on page 350 of the Reference Manual.



3. Select each of the interior walls one at a time and click the **Open Object**  edit button. Check **Knee Wall** on the Roof tab of the **Wall Specification** dialog and click OK.

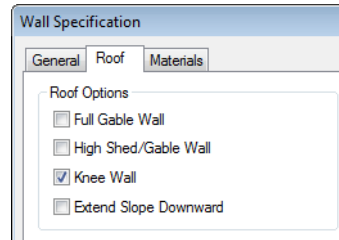

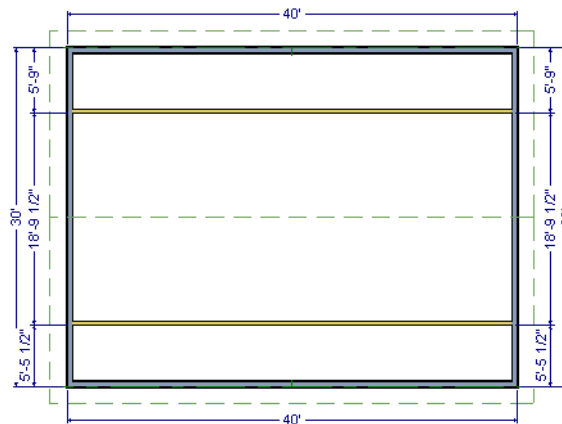

4. Select **CAD> Dimensions> Automatic Exterior Dimensions**  to create exterior dimension lines for your plan, which should now look like this:

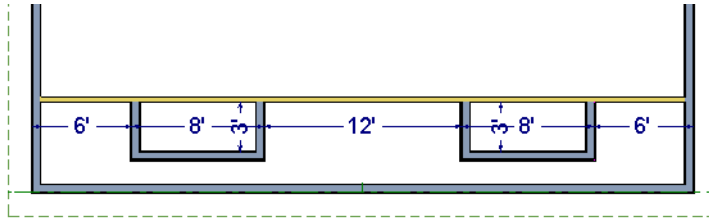

***To build the dormer walls***

1. Select **Build> Wall> Straight Exterior Wall**  and draw two rectangular boxes on the outside of the lower interior wall, as shown in the following image.
2. Position the lower walls of each dormer box 2 feet from the bottom wall. The lower dormer walls are those parallel to the bottom wall.
3. Edit each dormer box so that it is 6 feet from each vertical side wall and 8 feet wide.



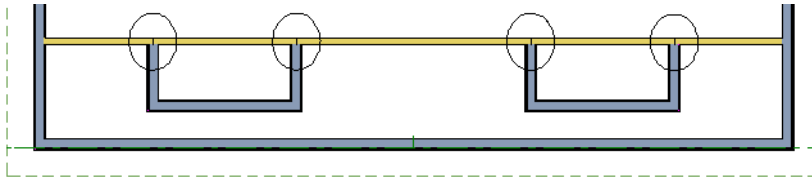

4. Select **Build> Wall> Break Wall**  and click along the lower interior wall to place wall breaks as indicated in center of each overall in the following image.



5. Delete the upper, horizontal portion of each window box.



***To add a window to each dormer***

1. Select **Build> Window> Window**  and click on each dormer front wall to place a window. The program may warn you that you are adding windows to an interior wall; click **OK** to continue.
2. Select the window; click the **Center Object**  edit button; and click near the wall containing the window to center it on the wall. See “Using Center Object” on page 90 of the Reference Manual.
3. Do the same for the other window.

***To build the roof***

1. Select the two dormer front walls that contain a window, open them for specification, and on the Roof tab of the **Wall Specification** dialog, check **Full Gable Wall** and click **OK**.

2. Select the dormer side walls, open them for specification, and on the Roof tab of the **Wall Specification** dialog, specify the **Pitch** for the dormer roof plane above the wall, and click **OK**. Earlier we specified a pitch of 12 in 12 in the **Build Roof** dialog, that pitch should have prefilled here. A steep pitch of 12 in 12 will work well for these dormers.
3. Double-click the narrow room above the top knee wall to open the **Room Specification** dialog, designate its **Room Type** as “Attic” and click OK.
4. Do the same for the lower attic room.

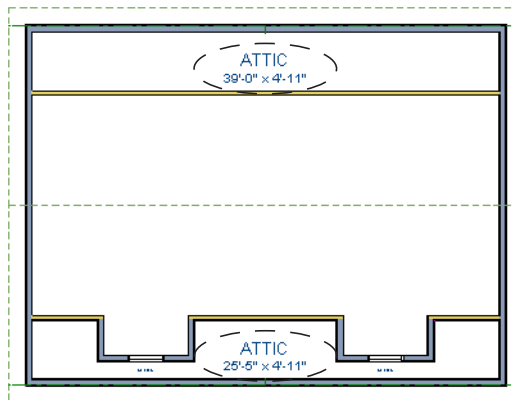

5. Select **Build> Roof> Build Roof**  from the menu.
6. In the **Build Roof** dialog and click OK.
7. Create a 3D view to see the results.



- Notice there are small gaps in the dormer side walls. This gap is caused by the difference between the position of the knee walls and the point at which the ceiling intersects the roof plane. This location is marked by the black dotted line in floor plan view.

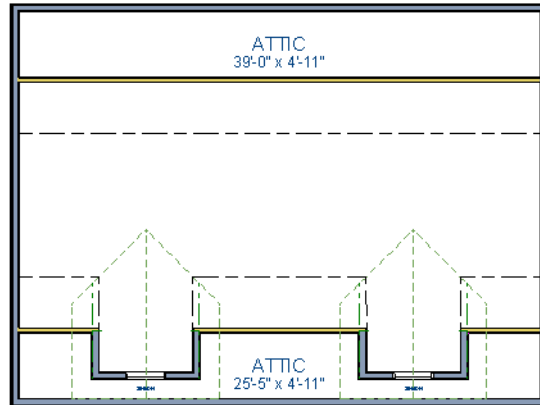

- Select each of the knee walls and move them back so that they are in alignment with the ceiling plane. The walls will snap into position when they are close to the ceiling lines.

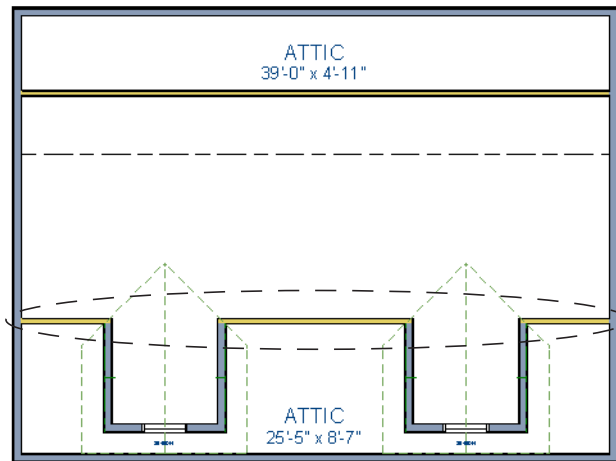

- Take a look in a 3D view.







You can move the interior walls closer to or further from the outside walls to change the dormers' elevation, or change the pitch for the roof to make the dormers longer. You can create dormers in more complex plans the same way, but you may want to experiment with wall placement and pitch to achieve the desired effect.

---

## Skylights

Skylights can easily be added using the **Skylight**  tool. In floor plan view, select **Build> Roof> Skylight**  then click and drag a rectangular shape within an existing roof plane. When you release the mouse button, a skylight is created and can be repositioned and resized using its edit handles. For more information, see “Skylights” on page 195 of the Reference Manual.

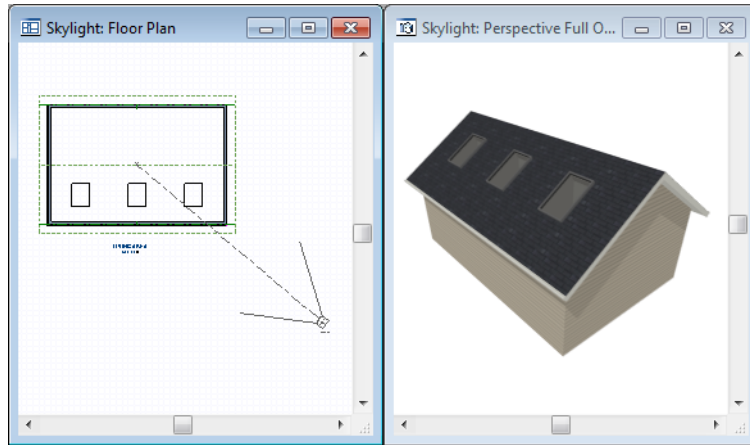

---

## Using the Break Wall Tool to Modify Roofs

Many homes have more than one roof type built above a single exterior wall. One common example is a reverse gable roof, created when a house has gable walls that are perpendicular to one another, as in an L-shaped home.

We can create a reverse gable roof on an L-shaped home using the **Break Wall**  tool.

### *To create an L-shaped home*

1. Select **File> Close All** from the menu.
2. Select **File> New Plan**  to open a new plan. In the **Create New Plan** dialog, select the Default Style template.
3. Draw an L-shaped house with the following dimensions:
  - Left wall - 30 feet long
  - Upper wall - 45 feet long.
  - Right wall 18 feet long.
  - Lower wall extending left from the right wall - 25 feet long.
  - Vertical wall connecting two lower walls - 12 feet long.
  - Lower wall extending right from the left wall - 20 feet long.

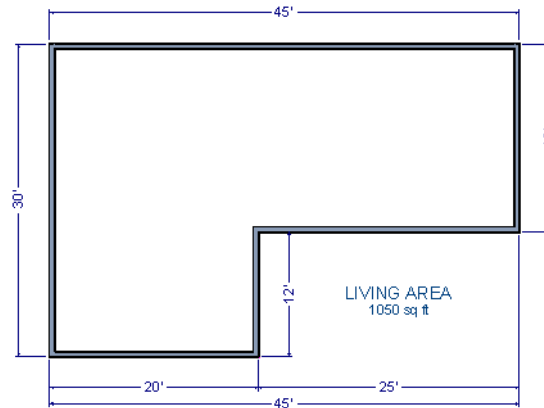

To create a reverse gable in this plan, we need to create three gable walls: two running vertically and one horizontally.

***To add a gable roof to the plan***

1. Check **Full Gable Wall** on the Roof tab of the **Wall Specification** dialog for these three walls:
  - The far left vertical wall
  - The far right vertical wall
  - The bottom left horizontal wall
2. Click the **Build Roof**  tool to open the **Build Roof** dialog and click OK to build the roof. Your plan should look like this:

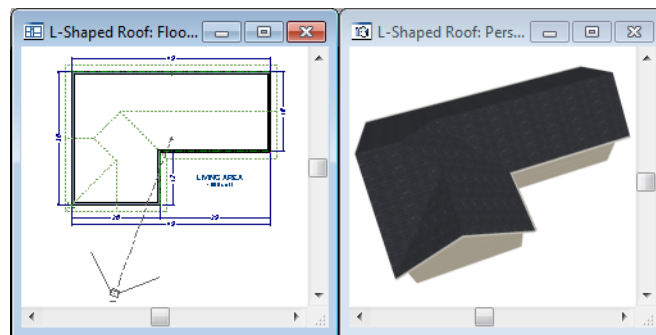



Built this way, the gable wall on the left produces roof planes that extend too high and will interfere with the roof over the lower part of the house. To correct this, use the **Break Wall** 

tool to break the left wall into two different sections. We can then specify the upper section as Full Gable without affecting the lower section.

***To use the Break Wall tool***

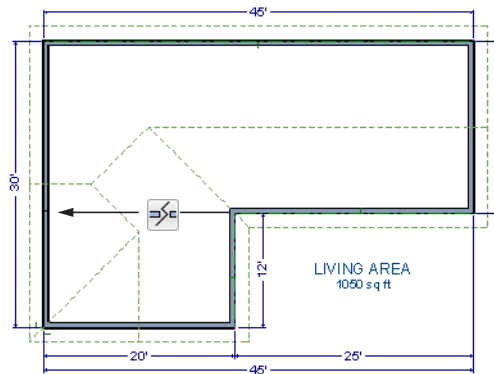
1. Select **Build> Wall> Break Wall**  and click the far left wall at a point even with the lower right wall.
  - An easy way to do this is to temporarily stretch the lower right wall across to the left wall;
  - Place a wall break where the walls meet;
  - Then return the lower right wall to its correct position.



2. Open the lower portion of the wall for specification and on the Roof tab of the **Wall Specification** dialog, clear the **Full Gable Wall** checkbox and click **OK**.
3. Click the **Build Roof**  tool and click **OK** to build a roof based on the new wall specifications.

You now have two full gable roof sections meeting to form your L-shaped roof. Your plan should look like the following image:

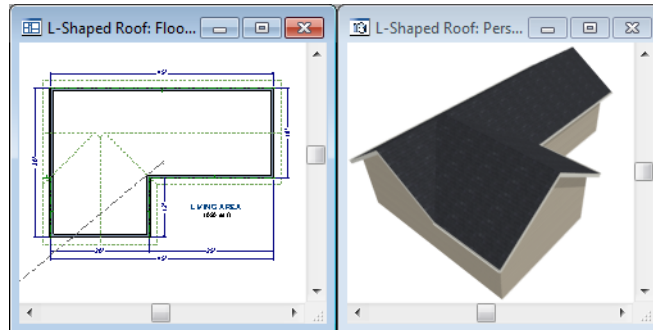

Notice the step in the ridge line. This can be corrected by resizing the lower gable wall. Select the vertical wall to the right of the bottom gable wall and move it to the left 2 feet, reducing the length of the gable wall from 20 to 18 feet. When you are finished, rebuild the roof.

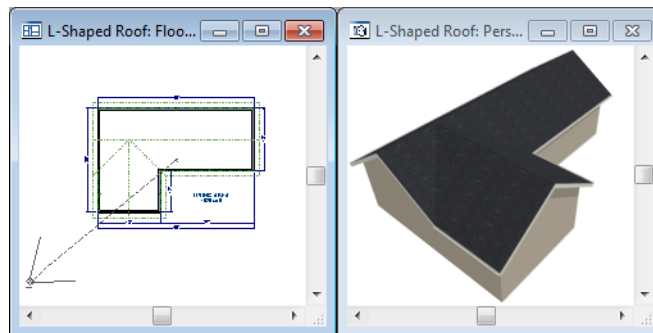

This completes this Roof Tutorial. You can use any combination of the techniques described here to create a wide variety of roof planes. Let's return to our Stucco Beach House plan and apply what we have learned.

---

## Adding a Roof





Now that we have a basic understanding of the automatically roof tools, let's return to our previously saved Stucco Beach House plan, as it looks like our house could use a roof now.

Let's select **File > Save As**  and give this plan a new name, such as "Beach House Roof Tutorial" before continuing.

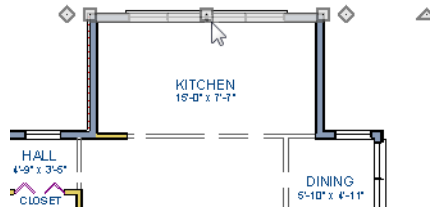
*To edit the default roof*

1. Close any other views you may still have open. For the following steps, only the floor plan view should be open.
2. Starting on Floor 1, we will start by using the **Select Objects**  tool to select the top horizontal exterior Kitchen wall, as indicated in the image below.



3. Click on the **Open Object**  edit button to display the Wall Specification dialog, go to the Roof tab, place a checkmark in the **Full Gable Wall** option, and click **OK**.
4. Click **Up One Floor**  to go to the second floor.
5. Using the **Select Objects**  tool, select the Balcony room, then click on the **Open Object**  edit button to open the Room Specification dialog, and on the Structure tab, uncheck **Roof Over this Room** if it is selected, then click **OK**.
6. Open the following second floor walls' specification dialogs and assign the settings shown in the following image on the Roof tab of the **Wall Specification** dialog. See "Roof Tab" on page 115 of the Reference Manual.

Individual walls can be selected and edited in both 2D and 3D views. See “Editing Walls” on page 107 of the Reference Manual.

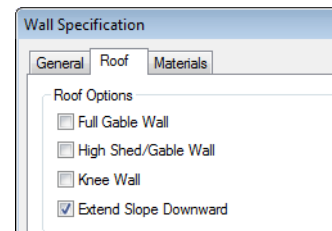
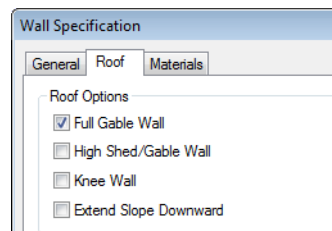
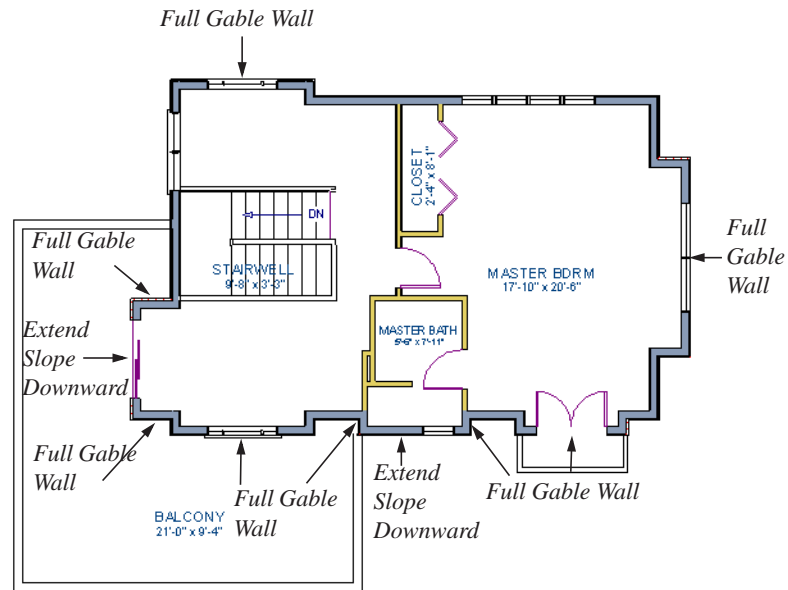

- Once we have completed defining these walls on Floor 2, we are ready to create our roof.

#### *To turn on automatic roof generation*

- Select **Build > Roof > Build Roof**  from the menu to open the **Build Roof** dialog.
- Set the **Pitch (in 12)** to 3".
- You can go to the **Materials** tab to change the material of your roof, where we will choose an Earth Roof Tile material.
- Click **OK** to close the dialog and generate a roof.
- Recall that the additional walls you now see displayed are attic walls.

6. Select **3D > Create View > Full Overview**  to create an exterior view of your plan.

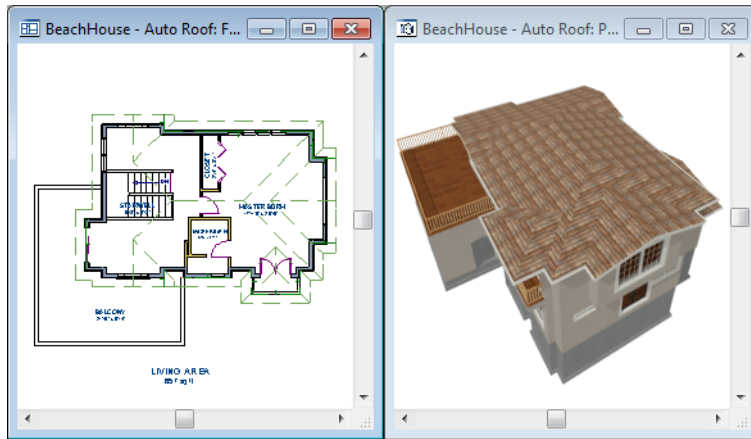

---

## Troubleshooting Roof Issues

Creating a roof can require experimentation and practice. Here are some suggestions for troubleshooting a problematic roof design.

### Roof Directives in Walls

As discussed in this chapter and in the Roofs chapter, the program will automatically generate a roof plane bearing over each exterior wall in a plan to produce a hip roof. If you require a different condition over a particular wall, such as a triangular gable or side wall of a shed roof, you can specify that condition on the Roof tab of the **Wall Specification** dialog. See “Roof Tab” on page 115 of the Reference Manual.

Specifying roof directives that do not reflect what you require directly above a selected wall, however, can often result in drastic and unwanted changes to your roof. For example, when two parallel walls are specified as Full Gable Walls, a single ridge will be created between them.



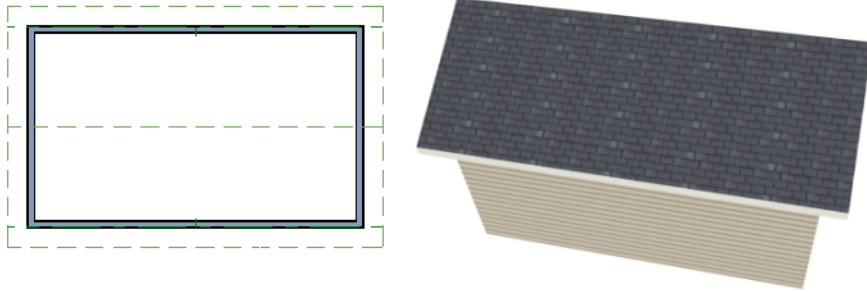

If a wall that is perpendicular to these walls is also specified as a Full Gable Wall, the roof becomes more complex with an additional ridge, two valleys, and two hips.

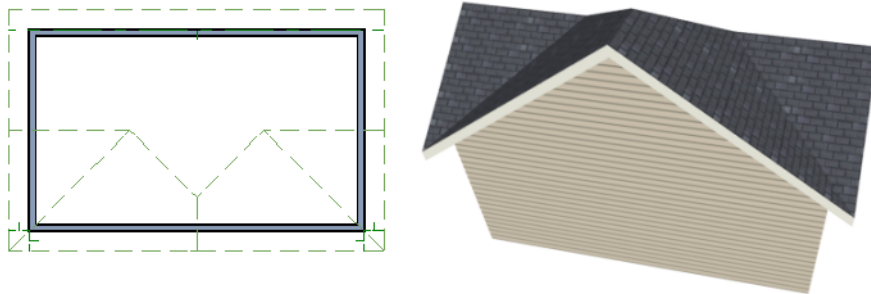

If you are seeing hips or valleys in your roof where you do not expect them, revisit the Roof tab of the walls supporting the affected roof planes.

## Roof Heights

The heights of all roof planes are based on the heights of the walls that they bear on. Wall heights, in turn, are determined by the ceiling heights of the rooms that they define. See “Floor & Ceiling Heights” on page 128 of the Reference Manual.

For example, the hip roof over a simple rectangular structure with a consistent ceiling heights (in this case, 109 1/8") has four roof planes.

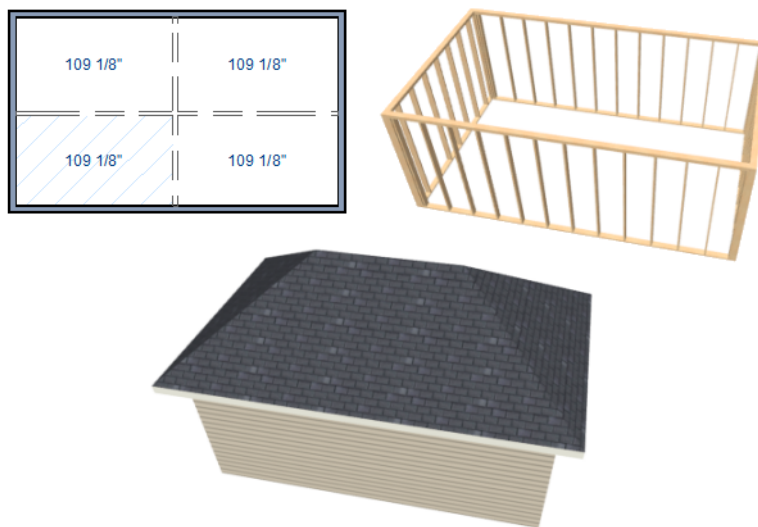

This roof will become considerably more complex if one room inside is given a lowered ceiling height (in this case, 97 1/8").

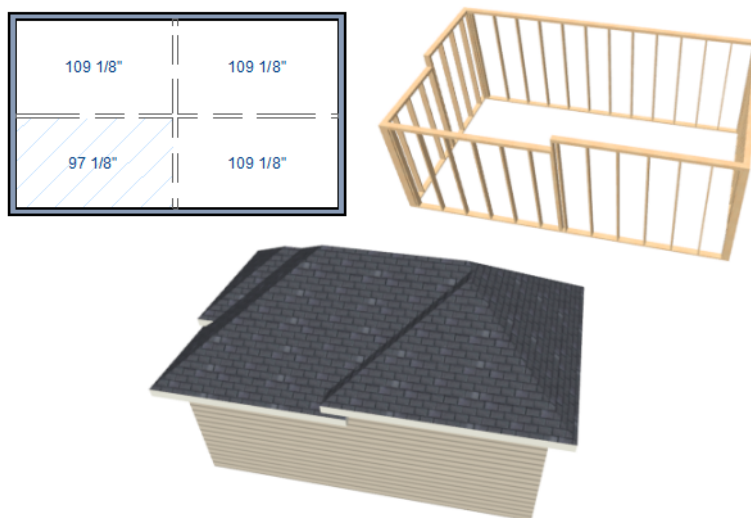

If you generate a roof and it seems to be more complicated and has more roof planes than it should, take a look at the ceiling heights of the rooms in the plan. Often, the correct way to

create a lowered ceiling condition will be to set the ceiling at the default height create a lowered Ceiling Finish. See “Lowered Ceilings” on page 129 of the Reference Manual.

## Controlling Roof Ridges

A single roof ridge will generate for as long as the bearing walls that support the roofs on either side of the ridge are the same distance apart. When alcoves or bumpouts are introduced along either bearing wall, the ridge is likely to become broken.

For example, a simple rectangular structure with Full Gable Walls at each end generates a roof with a ridge that runs from Full Gable Wall to Full Gable Wall.

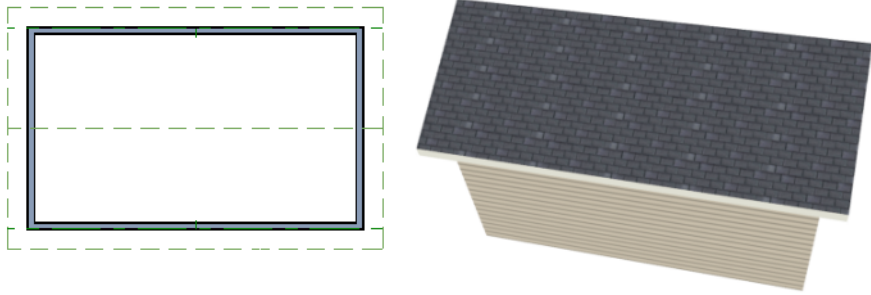

If a bumpout is added that affects the length of either Full Gable Wall, or if an alcove is added anywhere along the length of the structure, the ridge will no longer follow a straight line.

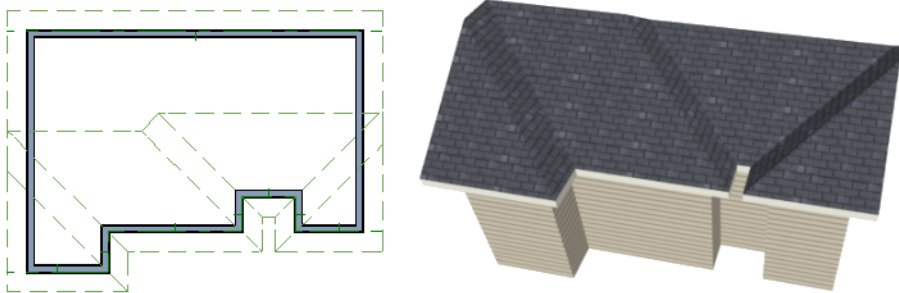

There are a number of ways to maintain a single ridgeline in the presence of alcoves or bumpouts:

- Use the **Break Wall**  tool to control the length of a Full Gable Wall section. See “Using the Break Wall Tool to Modify Roofs” on page 82.

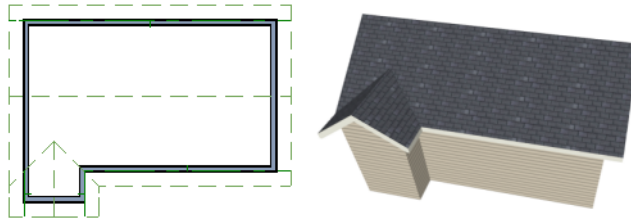

- Increase the **Minimum Alcove Size** to specify what size alcoves are roofed. See “Roof Tab” on page 193 of the Reference Manual.

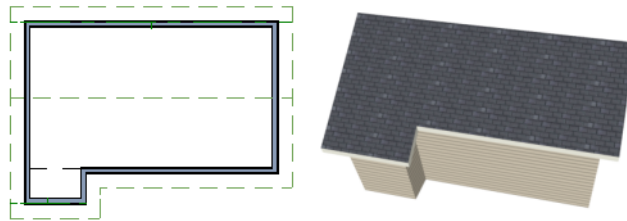

- Use the **Extend Slope Downward** roof directive to allow the roof over a bumpout to extend lower than the ceiling height in that area. See “Roof Directives in Walls” on page 111 of the Reference Manual.

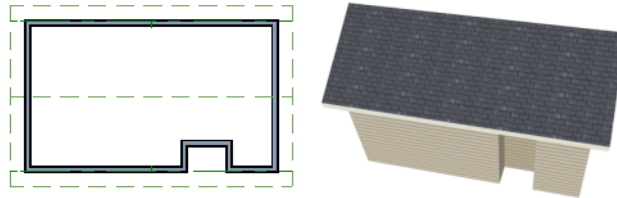

- Specify the area inside of an alcove as an "Open Below" room with a roof but no ceiling, and **Use Soffit Surface for Ceiling** specified. See “Room Types” on page 124 and “Structure Tab” on page 132.

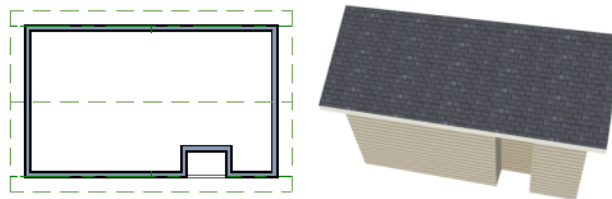

# Interior Design Tutorial

In the Interior Design Tutorial, we'll pick up where we left off in the House Design Tutorial. The shell and basic structure of our plan is complete, but a lot of interior finishing remains. Our plan still needs lights, outlets, and fixtures to be a functional home. In addition, the interior could use some creature comforts such as furniture and moldings. You may want to save this tutorial using a new name to archive your previous work. In this tutorial, you will learn about:



- Controlling the Display of Objects
- Working with Library Objects
- Applying Room Moldings

---

## Controlling the Display of Objects

We have a roof on our plan, but in this tutorial we'll be working on the plan's interior, so we do not need the roof planes to show in floor plan view. As we learned in the previous tutorial when we turned off the display of attic walls, the display of objects is controlled in the **Display Options** dialog. For more information about layers and using the **Display Options** dialog, see "Layers" on page 58 of the Reference Manual.

*To control the display of objects*

1. First, let's make sure to select **File> Save As**  and give this version of our plan a new name, such as "BeachHouse - Interior Tutorial"
2. Select **Tools> Display Settings> Display Options**  (or press the ~ key) to open the **Display Options** dialog.
3. Press the letter R, find the layer "Roof Planes" and remove the check from the Display column. Click OK.

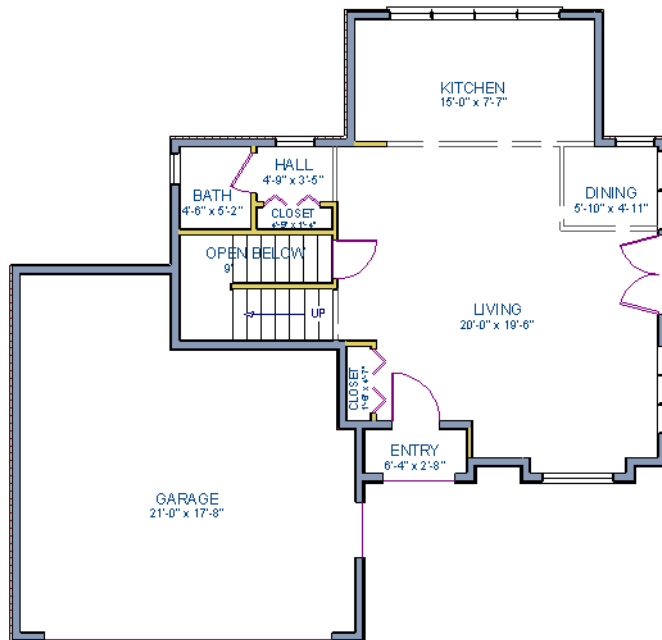

*Floor 1 with the display of door and window labels and roof planes turned off*



---

## Working with Library Objects

Home Designer Essentials comes with a library that contains thousands of library objects that can be used in a plan. For more information about the library and library objects, see “The Library” on page 282 of the Reference Manual.

*To use the Library Search feature to locate a symbol and place it in the plan*

1. Move up to Floor 2 using the **Floor Up**  tool.

2. Select **Library > Library Browser**  (or press Ctrl + L on your keyboard) to open the Library Browser.
3. Click the **Turn on search filtering options**  button, then check **Match entire word**.
4. In the text field, type "bed" and notice that search results will display below as you type.
5. Click on a bed in the search results list to select it for placement.

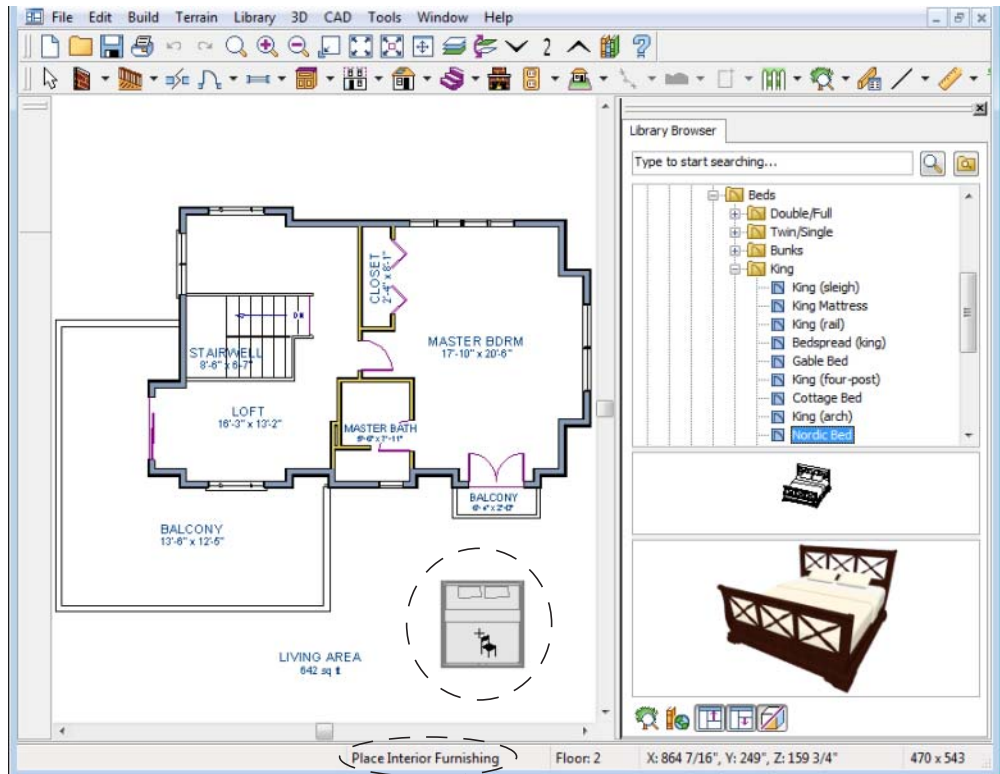

When a library object is selected for placement the mouse pointer icon indicates the type of library object selected, a preview outline of the object displays in floor plan view, and basic information displays in the Status Bar at the bottom of the program window.

6. Click in the master bedroom to place the bed.

Library objects can be selected and edited using the mouse. They can also be opened for specification, a method that offers the most complete editing capabilities. See “Symbol Object Specification Dialogs” on page 297 of the Reference Manual.

*To use library search to place a furniture symbol*

1. Click the **Select Objects**  button (or press the Spacebar) and click on the bed to select it. When selected, the bed displays edit handles. For more information, see “Editing Box-Based Objects” on page 82 of the Reference Manual.

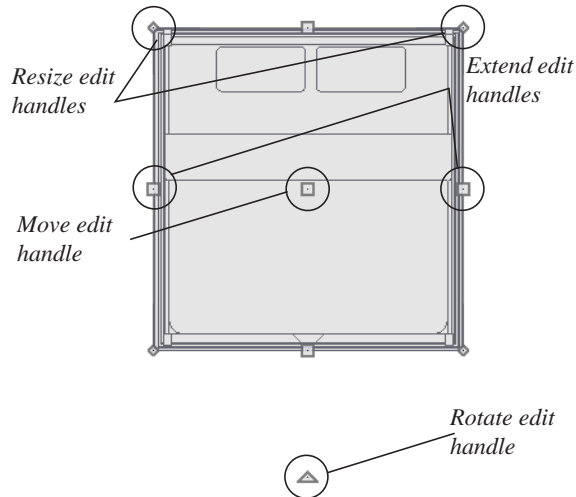

2. Use the Rotate edit handle to rotate the bed.
3. Use the Move edit handle to move the bed up against the right wall.

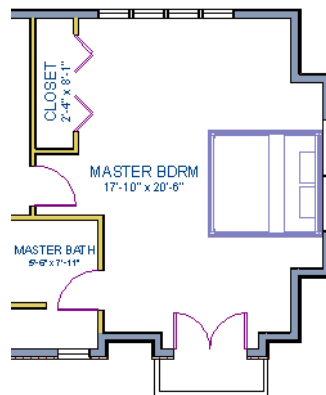

4. You can modify the materials for the bed by using the **Select Objects**  button tool to select the bed, and click on the **Open Object**  edit button to open the **Furniture Specification** dialog.



5. Next, select the Materials tab, and select the element of the object you want to apply a new material to, such as the Bedspread.
6. Click on the **Library Material** button to display the Select Library Object dialog, which allows you to browse materials available in the Library to apply as the bedspread. For the purposes of our example, we will choose a light brown fabric.
7. Repeat this process for any of the other materials on the bed you may want to adjust, then click **OK** to apply the changes which will be visible when you create a camera view.

Now we'll place some fixtures. If you cannot find what you're looking for, the **Library Search** feature can help.

#### *To use library search to place a fixture symbol*

1. Select **Library > Library Browser**  to open the **Library Browser**.
2. Type "toilet" into the search field at the top of the browser window. As you type, search results display in the Directory pane.
3. Select the Standard toilet from the search results.
4. Click in the master bathroom to place the toilet.

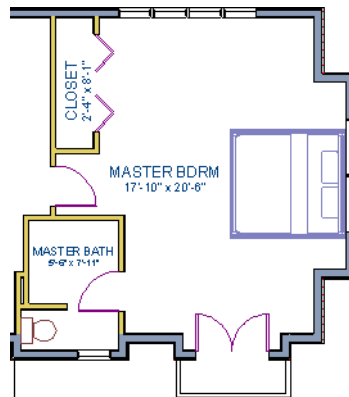

Using the tools and techniques learned so far, place fixtures and furniture in both bathrooms on Floor 2 and Floor 1.

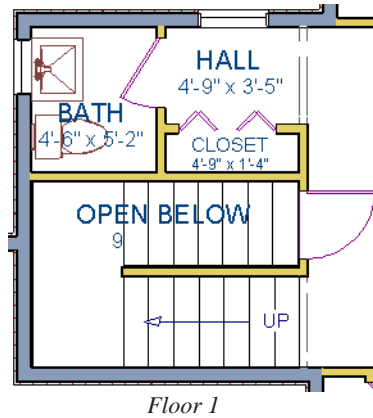

 If existing walls and/or other objects do not allow enough room for a library object to be placed, place the library object where there is enough room and move the object into place while holding down the **Ctrl** key on the keyboard.



---

## Applying Room Moldings

In Home Designer Essentials, you can specify base, crown and chair rail moldings for any room. We'll start by applying a crown molding in the master bedroom, and then we'll add a chair rail to the dining room.

**To add crown molding**

Now let's take a look at our master bedroom in a 3D view. See "To create a camera view" on page 42 for information about using the **Camera**  tool.

1. With the camera view of the bedroom still active, click the **Select Objects**  button or press the Spacebar, then click in a blank space on the floor of the room to select it.
2. Click the **Open Object**  edit button to open the **Room Specification** dialog for the master bedroom.
3. On the Moldings tab:

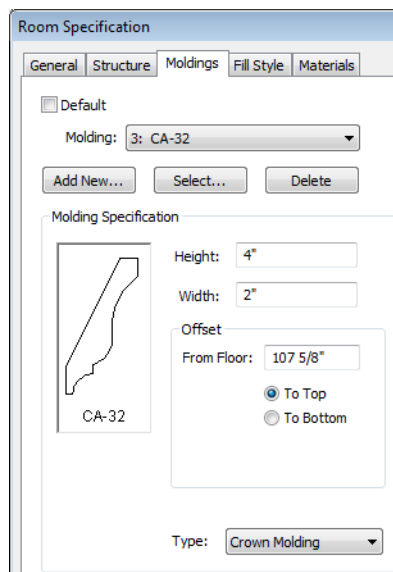



- Uncheck **Default**, and then click the **Add New** button.
- In the **Select Library Object** dialog, you can either search or browse to find a crown molding that suits your needs. When you find one, select it and click OK. For more information, see "Select Library Object Dialog" on page 295 of the Reference Manual.
- If you wish, you can specify the **Height** and **Width** of the selected molding. In this tutorial, a Height of 4 inches is specified.
- Select "Crown Molding" from the **Type** drop-down list and notice that the From Floor value is equal to the room's Finished Ceiling Height on the Structure tab.
- Click OK to close the **Room Specification** dialog.



Chair rail moldings can be applied to a room in the same manner. Base moldings are already applied in most room types by default, but can be edited, removed or added here, as well.

***To add chair rail***

1. With the camera view of the bedroom still active, click the **Select Objects**  button or press the Spacebar, then click in a blank space on the floor of the room to select it.
2. Click the **Open Object**  edit button to open the **Room Specification** dialog for the master bedroom.
3. On the Moldings tab of the **Room Specification** dialog:
  - Click the **Add New** button, and select a chair rail profile.
  - Specify a **Height** of 2" and set the **From Floor** value to 32" inches.
  - Click OK.



4. When you have finished, you may want to **Save**  your work.

If you would like, you can continue adding interior elements from the Library Browser before continuing to work on this plan in the Kitchen and Bath tutorial.





# Kitchen and Bath Design Tutorial

This tutorial continues where the Materials Tutorial left off. You should save this tutorial using a new name to archive your previous work.

The tools and techniques used to design kitchens and bathrooms are very similar. This tutorial focuses on kitchen design. When you're finished you can use what you've learned to finish up the bathrooms as well. In this tutorial you will learn about:

- Adding Cabinets
- Placing Appliances
- Editing Cabinets and Appliances
- Creating a Custom Countertop
- Editing Cabinets and Appliances
- Working in 3D Views

---

## Adding Cabinets

First, let's select **File> Save As** , and choose to name our plan BeachHouse - Kitchen Bath Tutorial.

We'll begin by placing a cabinet in the kitchen and editing its dimensions, orientation, and placement. For more information about cabinets, see "Cabinets" on page 242 of the Reference Manual.



### *To place a base cabinet*

1. **Zoom**  in on the Kitchen area in floor plan view.
2. Select **Build> Cabinet> Base Cabinet** .

3. Click to place a base cabinet anywhere in the kitchen.

Once a cabinet is placed, it can be edited like other objects.

**To select and edit a cabinet**

1. Cabinets can be selected using one of the following methods.
  - Click on the cabinet while the **Select Objects**  tool is active.
  - Click on the cabinet while any of the **Cabinet Tools**  are active. This allows only cabinets to be selected.
  - Right-click on the cabinet when another tool is active.
2. When the cabinet is selected, edit handles, a front indicator, and a temporary dimension display. As with other objects, the arrow that displays when the pointer is held over an edit handle indicates what edit function that edit handle will perform. See “Editing Box-Based Objects” on page 82 of the Reference Manual.

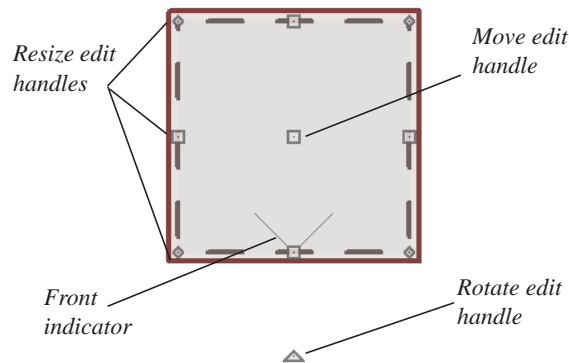

- Move a cabinet using the move edit handle. By default, you can move a cabinet along either the X axis or the Y axis. To allow unrestricted movement, hold down the **Ctrl** key (or click using the right mouse button) then drag the cabinet.
  - Resize two sides of a cabinet using a resize edit handle, located in each corner.
  - Extend a cabinet's edge on one side using an extend edit handle. One of the extend edit handles also displays an arrow that indicates the cabinet's front.
  - Rotate a cabinet using the rotate edit handle.
  - A temporary dimension updates as the cabinet is moved or resized.
3. When the cabinet is selected, you can also click the **Open Object**  edit button to open its specification dialog and make a wide variety of changes to the cabinet. For more information, see “Cabinet Specification Dialog” on page 251 of the Reference Manual.



***To lay out base cabinets for this tutorial***

- Place and position several initial base cabinets in your plan and edit their width and orientation as shown in the following image.
  - Notice that two of the cabinets are 36", two are 24" wide, one is 33" and one is 27" wide.
  - A cabinet snaps to another if they are in alignment, facing the same direction, and of the same type.

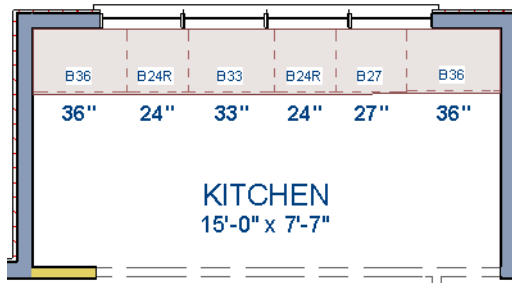

Note: The display of cabinet module lines has been turned on in the following images. See "Displaying Cabinets" on page 247 of the Reference Manual for more information.

***To create corner cabinets***

- Select the three foot base cabinet at upper right.

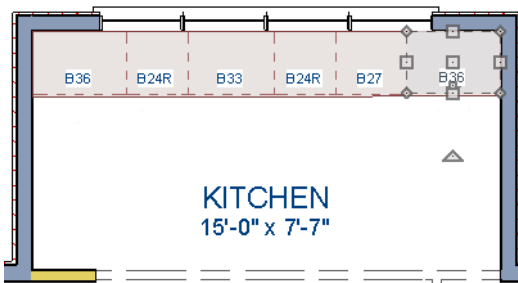

- Click the **Open Object**  edit button to open the **Base Cabinet Specification** dialog. On the General tab:
  - Specify a **Width** greater than the Depth. The selected cabinet's width should already have been changed to 36", which works well with a 24" depth. If it isn't, change it to 36" now.
  - Click the **Special** drop-down list and select Corner.
  - On the Front tab, uncheck the box beside **Diagonal Door**.

- Click **OK** to change the cabinet into a corner cabinet.

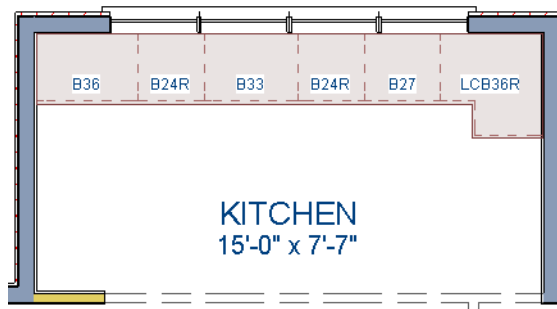

3. Repeat this process with the upper left Base Cabinet and open it for specification:
  - On the General tab, change it to a corner cabinet (as we did in the previous step).
  - On the General tab, change the **Left Side Width** to 36 inches (36").
  - On the Front tab, uncheck the box beside **Diagonal Door** if it is checked.
4. Click OK to close the **Base Cabinet Specification** dialog, then select this cabinet, use its rotate edit handle, then move it into the corner, until it bumps into the walls.

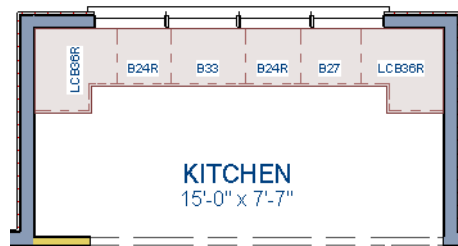

Note: To move a group of cabinets, select one cabinet, place the pointer over the move handle, the click and drag the mouse cursor and you can push the entire group of cabinets.

#### *To place wall cabinets*

1. Select **Build> Cabinet> Wall Cabinet** .
2. Click very above the left corner base cabinet to place a wall cabinet as shown.

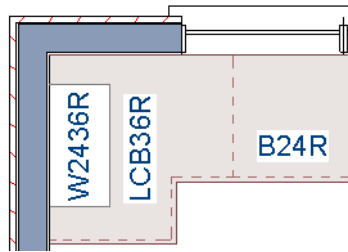

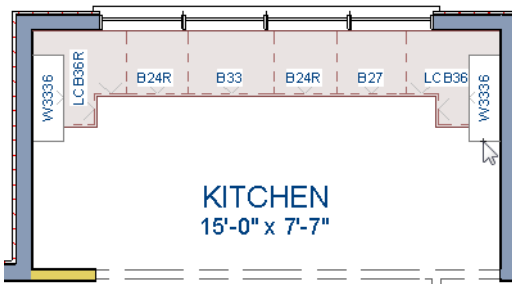

- Click the **Open Object**  edit button to open the **Wall Cabinet Specification** dialog:
  - On the General tab, specify a **Width** of 33.
  - On the Door/Drawer tab, change the Door Style to **Framed Doors**, and check **Glass Doors** if it is not already selected.
  - Click **OK** to apply these changes to the wall cabinet.
- Once you have finished modifying the original wall cabinet, select it and click on the Copy edit tool, then click near the opposite wall to place a second wall cabinet identical to the first, and rotate it so that it faces out in to the door, instead of in to the wall.



Note: The display of cabinet face indicator lines has been turned on in the following images. See "Displaying Cabinets" on page 247 of the Reference Manual for more information.

### *To place soffits*

Select **Build> Cabinet> Soffit**  then click above the wall cabinets to place soffits. Adjust their width and orientation to match the wall cabinets below.

 When objects are very close to one another or occupy the same vertical space in floor plan view, it may be difficult to select the intended object. You can select an objects, then click the **Select Next Object**  edit button or press the Tab key to select a neighboring object. The Status Bar indicates which object is currently selected.

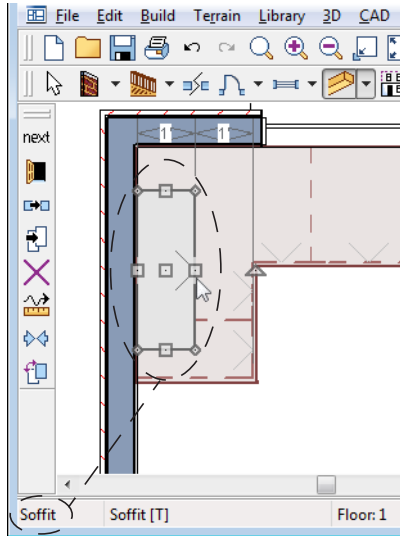

---

## Placing Appliances

Appliances come in two basic varieties, freestanding and built-in. Most plans use both types, including this one. For more information about library objects such as appliances, see “The Library” on page 282 of the Reference Manual.

### *To place a freestanding appliance*

1. Select **Library> Library Browser**  to open the Library Browser.
2. Go to **Architectural> Appliances> Refrigerators**, locate a refrigerator, and select it for placement.
3. On the left of the kitchen, click in the empty space to the bottom of the base corner cabinet to place the refrigerator.

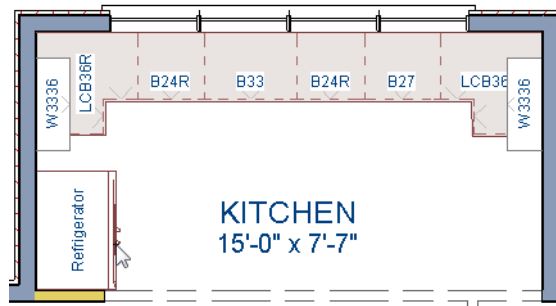

4. In the Appliances library, find the electric range and select it for placement.
5. Place the range in the empty space on the right of the kitchen.

***To place a built in appliance***

1. Open the Fixtures category to the Sinks library, find the double self-rimming 32 inch sink and select it for placement. For the purposes of this tutorial, we used the Offset 32" sink.
2. Click on the base cabinet near the top of the screen that is 33" wide to place the sink.
3. In the Appliances library, find a basic dishwasher, select it for placement, and click on the cabinet to the right of the sink.

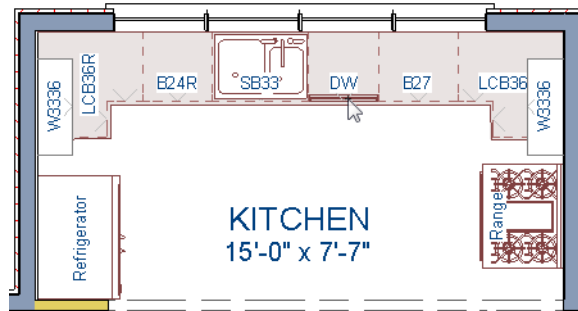



---

## Editing Cabinets and Appliances

We've already learned how to edit the dimensions of cabinets and appliances in floor plan view. Like other objects, cabinets and appliances can also be edited in their own specification dialogs. This method allows a higher degree of customization.

*To edit cabinets in the Cabinet Specification dialog*

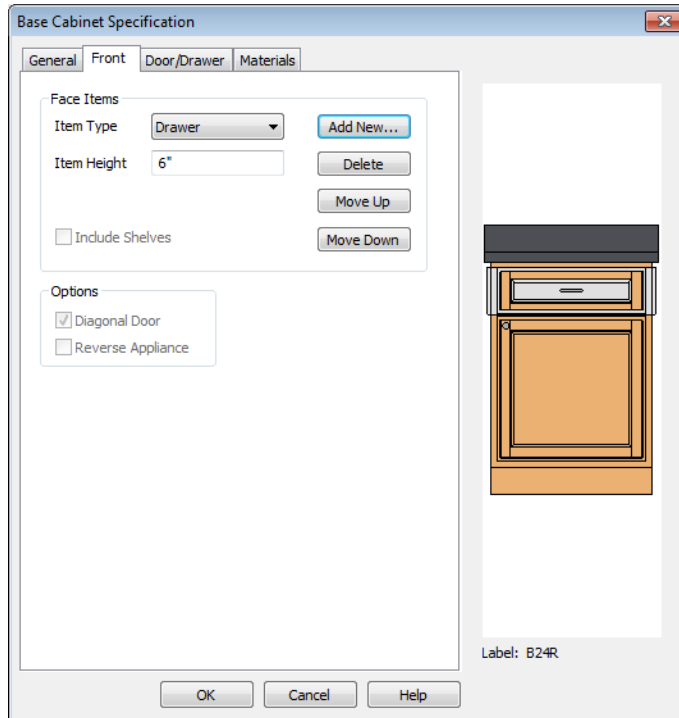
1. Select the cabinet to the left of the sink and click the **Open Object**  edit button to open the **Base Cabinet Specification** dialog.
2. Select the drawer in the preview. Notice that clicking anywhere on the preview takes you to the Front tab.



3. Click the **Add New** button to open the **New Cabinet Face Item** dialog.
4. Click the **Item Type** drop-down list and select Cutting Board, assign an **Item Height** of 1 inch, and click **OK** to return to the **Cabinet Specification** dialog.

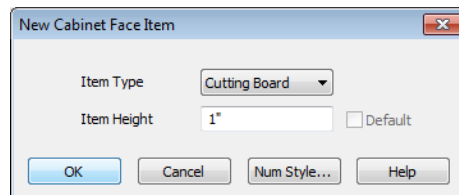

5. A new Cutting Board face item, as well as a new Separation, will be added below the drawer that you selected.

6. Click on the cutting board in the preview, then click the **Move Up** button three times to move the cutting board above the drawer and the empty spaces above and below it.
7. Select the Separation and click the **Move Up** button three times, as well.

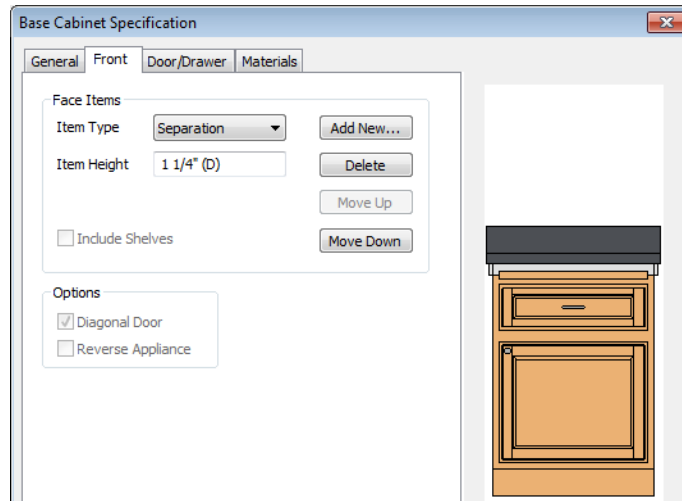

8. Click OK to close the **Base Cabinet Specification** dialog.
9. Follow this same procedure to make any additional changes to the other cabinets in your kitchen area, such as creating a bank of drawers, or changing the handle for drawers to be knobs.
10. Finally, we will add in several smaller base cabinets to fill in the gaps between appliances

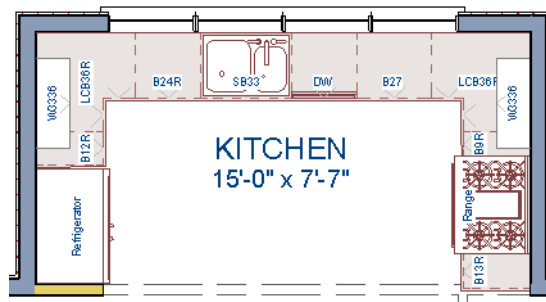

***To edit appliances in their specification dialogs***

1. Select the refrigerator and click the **Open Object**  edit button to open the **Fixture Specification** dialog.
2. On the General tab, change the **Depth** to 28 and click **OK**.



## Creating a Custom Countertop

### *To create a cabinet island*

1. Select **Build> Cabinet> Base Cabinet** .
2. Click to place a base cabinet in the kitchen area, and select it.
3. Click the **Open Object**  edit button to open the **Base Cabinet Specification** dialog.
  - On the General tab, specify a **Height** of 33", a **Width** of 33" and a **Depth** of 27";
  - On the Front tab, create 3 **Double Drawers** each having an **Item Height** of 7 1/2":

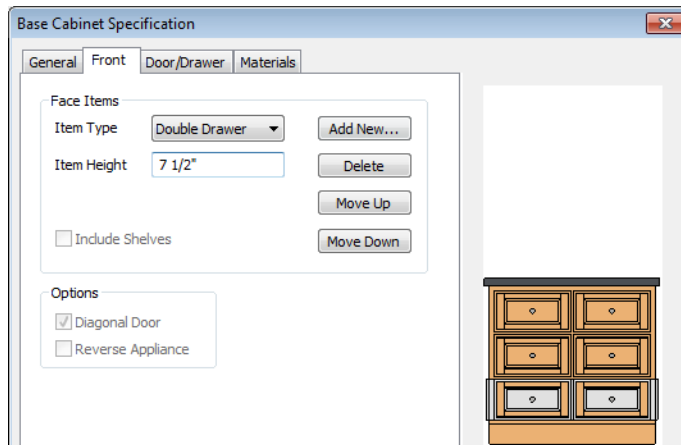

- On the Door/Drawer tab, set the Drawer Handle to **Knob**;
  - Click **OK**.
4. With the Base Cabinet still selected, click on the **Copy/Paste**  edit tool, and paste a copy of this modified cabinet next to the first, as in the image below.



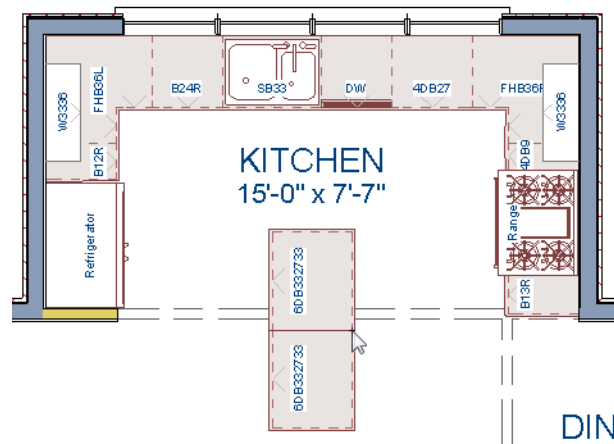

- For the next portion of this tutorial, we will turn off the display of cabinet labels by selecting **Tools > Display Settings > Display Options** , scroll down to the Cabinets, Labels layer, remove the checkmark the **Disp** column, and click **OK**.

Next we'll place one more base cabinet and then turn it into a countertop for a breakfast bar.

*To place a cabinet that will become a countertop*

- In floor plan view, place a **Base Cabinets**  and orient it so that its back is to the side of the lower base cabinet, near the dining room.

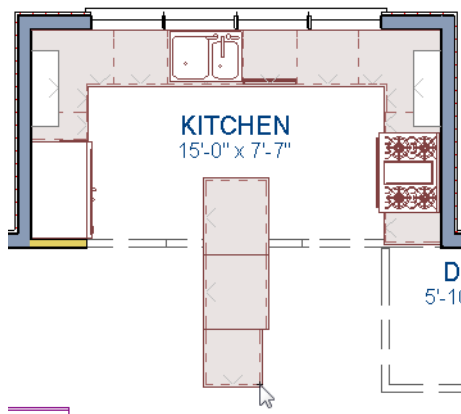

- Adjust its width so that they align with the cabinets behind them.
- Adjust its depth to 10 inches.

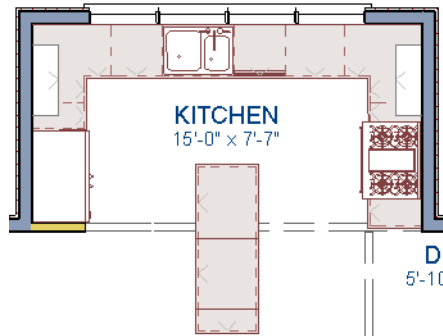

4. Select the 10 inch deep cabinets and click the **Open Object**  edit button.
5. On the Front tab of the **Base Cabinet Specification** dialog, click on the Toe Kick in the preview diagram to select it, then click the **Delete** button.
6. On the General tab of the dialog, select "Pen. Radius" from the **Special Type** drop down list, then set the **Height (Including Counter)** as 2" and the **Floor to Bottom** value as 31".

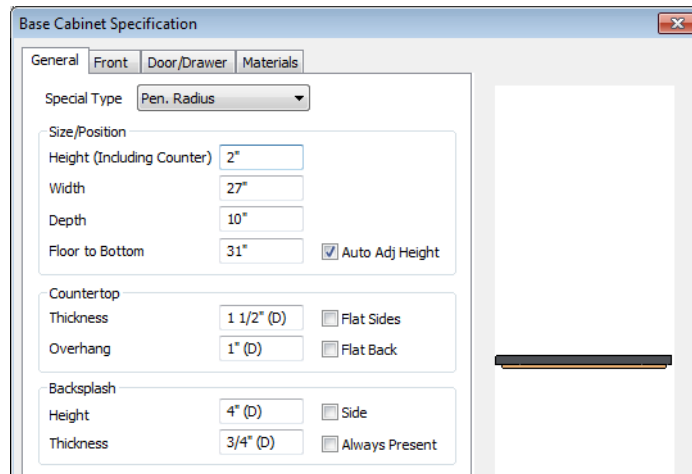

7. Press the Tab key and notice that the preview image on the right side of the dialog updates to show a countertop with a narrow band of cabinet material beneath it, then click OK.
8. Create a **Camera**  view to see the results.



- Finally, let's return to the Floor Plan view, add one more Wall Cabinet and Soffit above it on the right side of the kitchen, and resize them so that they are slightly wider than the Range below them.

---

## Working in 3D Views

Like other objects, cabinets can be edited in 3D views. This method of editing is very powerful and allows objects to be edited easily in vertical space. Next we'll edit wall cabinets and add a range hood. For more information about working in 3D views, see "Working in 3D" on page 331 of the Reference Manual.

### *To create a 3D view*

- Select **3D> Create Camera View> Full Camera** , then click and drag a camera arrow towards the group of cabinets that includes the electric range.

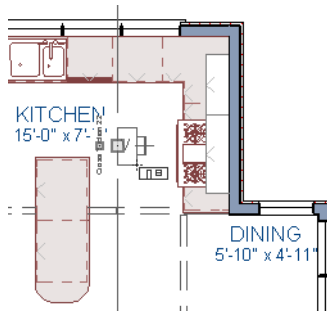

- Zoom**  in on the kitchen.



***To edit the cabinets in a 3D view***

1. Click the **Select Objects**  button, then click on the wall cabinet above the range, which should have double doors and be slightly wider than the base cabinet below it.
2. Click on the cabinet's bottom edit handle and drag it upwards.



3. When the temporary dimension indicates that the cabinet height is 18 inches, release the mouse button.

***To place a range hood***

1. Find a range hood from the Fixtures Library (Architectural> Appliances> Hoods> Large) and select it for placement.
2. Click above the range to place the hood.
3. If necessary, adjust its height and size using its edit handles.







## Finishing Touches

You may want to add a few finishing touches.

- While we're at it, let's add some additional interior design elements from the Library Browser, including stools to our new bar in the kitchen (Interiors> Furniture> Seating> Stools).
- Add furniture to the dining nook and change the flooring to match the kitchen.
- Add a table and some chairs to the dining area.
- Continue placing objects from the Library Browser to customize the remainder of the house design.

### *To view our kitchen using the Cross Section Slider and Final View*

1. In floor plan view, click **Fill Window** .
2. Create a **Camera**  view that starts from the exterior and release the mouse button in the kitchen. See “To create a camera view” on page 42.
3. Use the **Mouse-Orbit Camera**  tool to adjust the camera's perspective. If you want, you can turn off the display of the backdrop in the **3D Backdrop** dialog. For more information, see “3D Backdrop Dialog” on page 319 of the Reference Manual.
4. Select **3D> Cross Section Slider**  to open the **Cross Section Slider** dialog.

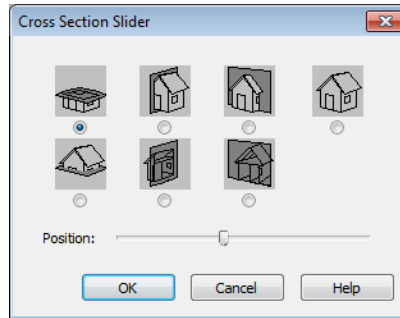

5. Select the flat cut line and use the position slider to specify the location of the cutting plane. See "Cross Section Slider" on page 330 of the Reference Manual.
6. Select **3D> Final View**  to create a higher quality final view.



7. In a future tutorial, we will be returning to this plan file, so be sure to **Save**  your work. If you would like, you can continue working on this plan in the Landscaping Tutorial.

# Materials Tutorial

Materials display on the surfaces of objects in 3D views and can make a 3D view appear highly realistic. When applied to most objects, material quantities will also be calculated in the Materials List.

This tutorial continues from where the Interior Design Tutorial ended. You may want to save this tutorial using a new name to archive your previous work. In this tutorial you will learn about:

- Setting Materials Defaults
- Using the Materials Tab
- Using the Material Painter
- Using the Material Eyedropper
- Blending Colors with Materials
- Using the Material Eyedropper
- Custom Materials, Images, and Backdrops
- Generating a Materials List

---

## Setting Materials Defaults

Material default settings determine the materials used by different objects when they are initially created. Setting the correct material defaults before beginning a project may help you save time. For more information, see “Preferences & Default Settings” on page 46 of the Reference Manual.

*To set material defaults*

1. Select **Edit> Default Settings**  to open the **Default Settings** dialog.

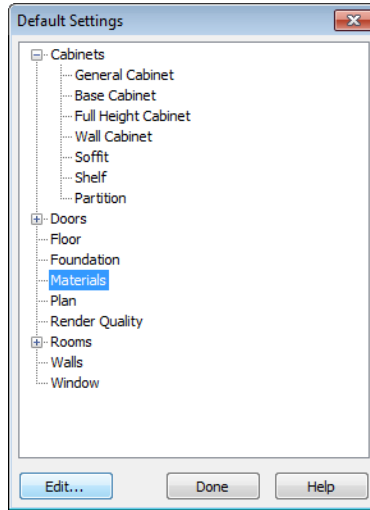

2. There are a two options. You can do either or both:
  - Select an item in the tree list and click the **Edit** button to open the defaults dialog for that type of object. The default dialogs for architectural objects such as doors and windows have a Materials tab that allows you to set the material defaults for object components. See “Using the Materials Tab” on page 121.
  - Select **Materials** and click the **Edit** button to open the **Material Defaults** dialog. Here you can set the material defaults for many different objects, including some that do not have default dialogs. See “Material Defaults” on page 308 of the Reference Manual.

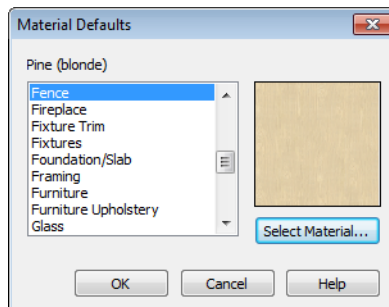



- When you are finished, click **OK** to close the defaults dialog, then click **Done** to close the **Default Settings** dialog.



Once an object has been placed in a plan, the materials applied to it can be changed in a number of ways.

---

## Using the Materials Tab

Most objects' materials can be assigned in their specification dialog in both 2D and 3D views. The materials used by a door, for example, can be edited on the Materials tab of the **Door Specification** dialog. For more information, see "Materials Tab" on page 303 of the Reference Manual.

### *To change material on an object using the Materials tab*

- Click the **Select Objects**  button, then click on the double door leading from the master bedroom to the deck on Floor 2 to select it.
- Click the **Open Object**  edit button to open the **Door Specification** dialog.
- Select one of the door's components from the list on the left.

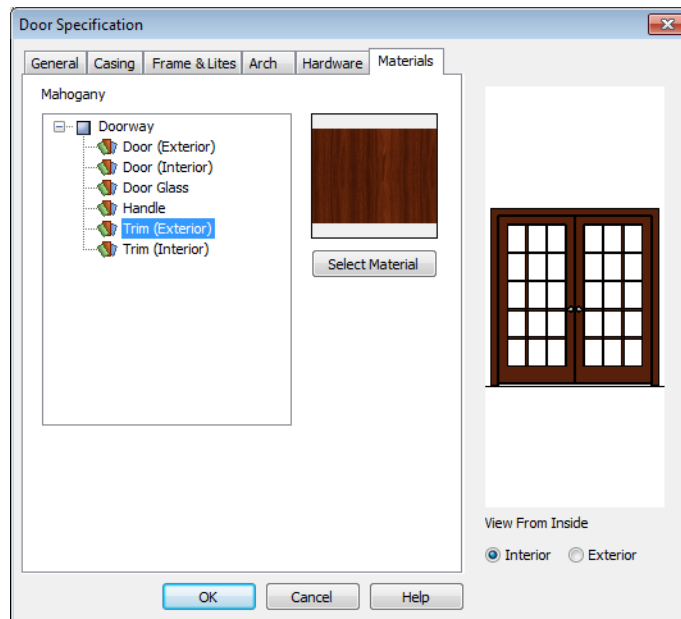

- Click the **Select Material** button to open the **Select Library Object** dialog.

4. Find and select a material and click **OK**.
5. You can continue to specify component materials. The preview in the dialog updates as changes are made. When finished, click **OK** to close the specification dialog.
6. Create a **Camera**  view of the door.



The materials used in individual rooms can also be specified. Rooms can be selected in both floor plan and 3D views.

- In floor plan view, click in an empty space within a room. When selected, the whole room is highlighted. If you accidentally select an object other than the room, you can press the Tab key on the keyboard until the room is selected.
- In camera views and overviews, click on the floor of the room to select it.

*To edit a room using the Materials tab*

1. Select the master bedroom and click the **Open Object**  to open the **Room Specification** dialog.
2. On the Materials tab, select Molding under the Crown Molding heading and click the **Select Material** button to open the **Select Library Object** dialog.

- Find and select a material and click **OK** to close the dialog.

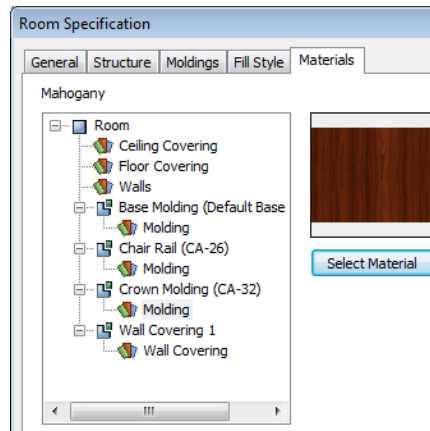

- Click **OK** to close the **Room Specification** dialog.
- The results can be seen in a **Camera**  view.





## Using the Material Painter

The **Material Painter**  tool allows you to select a material and then apply it to an object in a 3D view.

There are five Material Painter Modes which specify how broadly or narrowly the selected material will be applied to surfaces in your plan. In this tutorial, the **Component Mode** is used. For more information, see “The Material Painter” on page 301 of the Reference Manual.

*To apply a material using the Material Painter*

1. While still in the 3D view of the door, select **3D> Material Painter**  and confirm that there is a checkmark next to **Material Painter Component Mode** .
2. Click the **Material Painter**  button to open the **Select Library Object** dialog. Browse to Flooring> Carpeting, select a carpet material, and click OK.

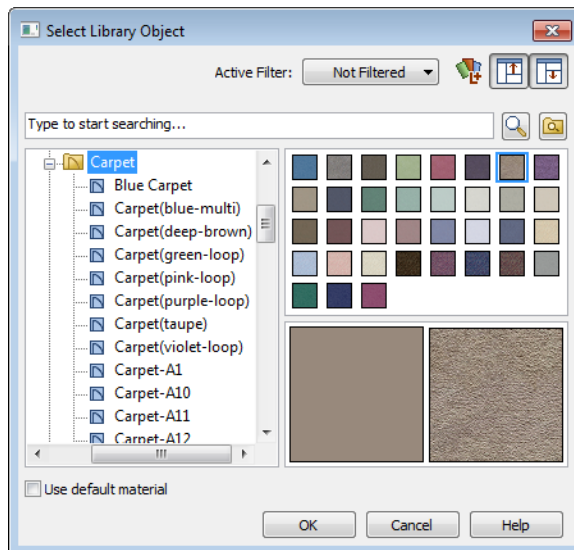



3. Move your cursor into the 3D view and notice that it displays a spray can icon .



- Click on the floor of the master bedroom to apply the selected material to that surface, which is a component of the room.



As an alternative to wall-to-wall carpeting, you can place an area rug symbol from the library in a room and assign to it whatever material you wish. See “Placing Library Objects” on page 293.

With the **Material Painter**  tool you can apply a material to nearly any surface, including many that can't be individually selected like the base molding on a wall or the frame of a window. When either the **Component**  or **Object**  Modes is active, you can continue to apply the selected material to objects until a different tool is selected.

#### *To add artwork to a frame*

- A variety of frames can be found in the Interiors library category. Place a wall or desk frame in your plan and create a camera view in which it can be seen.
- Select **3D> Material Painter** and confirm that there is a checkmark next to **Material Painter Component Mode** .
- Click the **Material Painter**  button to open the **Select Library Object** dialog and select a painting, photo or print from the Artwork library.



4. Move your cursor over the middle area of the frame and click to apply the selected artwork.









The artwork displayed in a frame can also be specified in the frame's specification dialog. See "Symbol Object Specification Dialogs" on page 297 of the Reference Manual.

---

## Blending Colors with Materials

Instead of using the **Material Painter**  to replace a material with a new one, we can use it with the **Blend Colors With Materials**  feature to blend a color with a textured material such as the carpet we selected for the master bedroom and create a new material. For more information, see "Blend Colors With Materials" on page 302 of the Reference Manual.

### *To blend a color with a texture*



1. In a 3D view, select **3D> Material Painter> Material Painter** .
2. In the **Select Library Object** dialog, select a solid color for the carpet from the Generic Colors library, then click OK.
3. When you move your cursor into the view, it displays a paint roller icon .
  - When **Blend Colors with Materials**  is active and a solid color is loaded in the Material Painter, your cursor displays the paint roller icon .
  - If you see the spray can icon  instead, select **3D> Material Painter> Blend Colors With Materials**  to turn this feature on.

4. Click on the carpet to blend the selected color with the carpet texture. The result is a new material with the textured appearance of the carpet as well as the color you selected.







---

## Using the Material Eyedropper

The **Material Eyedropper**  tool allows you to load a material that can be seen on a surface in a 3D view into the **Material Painter**  tool and then apply it to another surface. In our master bedroom, the type of wood we have assigned to the interior trim of the exterior door is

different than the material used on the trim of the interior doors. We can easily change this using the **Material Eyedropper** .



1. Activate the camera view (or any 3D view).
2. Select **3D> Material Painter> Material Painter**  from the menu. If there is a check beside **Blend Color With Material** , select this menu item to disable it; if not, simply click outside of the menu to close it again.
3. Select **3D> Material Painter> Material Eyedropper**  and notice that the pointer displays an eyedropper icon .





4. Now just click to load that material. Notice that the pointer changes to a spray can , indicating that the loaded material is ready to apply to another object and replace the existing material.
5. Click on the moldings to apply the loaded material.



---

## Custom Materials, Images, and Backdrops

Home Designer Essentials allows you to customize your 3D views by importing your own materials, image objects, and backdrops that display in 3D views. For more information about images, see “Pictures, Images, & Walkthroughs” on page 370 of the Reference Manual.

Note: The following steps make use of image files that are not included with the program. You can use image files that are already on your computer or you can create new ones. You can even use the same image file to create a material, an image, and a backdrop. Learning the tools and techniques described is more important than the appearance of the final product.

### Creating Materials

Materials are special digital images that can be applied to the surfaces of objects. You can create your own custom materials and save them in the library. Bear in mind that materials typically cover a surface by tiling an image repeatedly and are specially edited so that they tile seamlessly: as a result, not all images will necessarily serve as effective materials.

Once a material is saved in the library, it can be applied to objects in any plan, either using the objects’ specification dialogs or the **Material Painter** tool.

*To add a new material to the library*

1. Select **Library> Library Browser**  (or press Ctrl + L) to open the Library Browser.
2. Right-click on the User Catalog 'folder and select **New> Material** from the contextual menu to open the **Define Material** dialog.
3. Give the new material a short, descriptive **Name**.

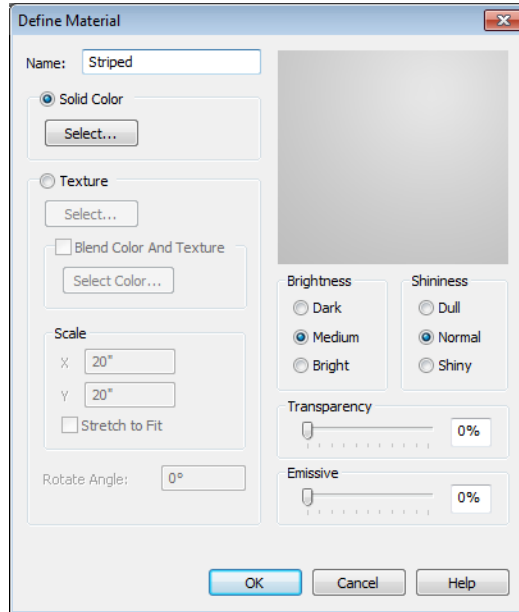

- On the Texture tab, click the **Browse** button to display the **Select Texture File** dialog, where you can select an image file saved on your machine.

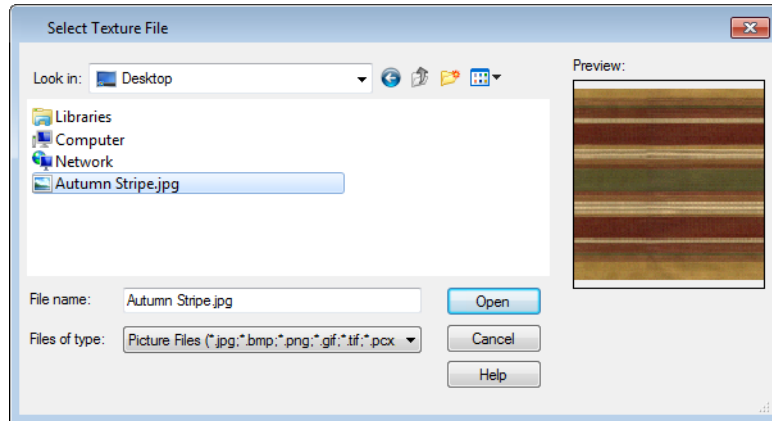

- Select an image file and click the **Open** button to return to the **Define Material** dialog.
- Specify the **Scale** of the texture, which controls how large the image will appear on the surfaces it is applied to.
- Click **OK** to add the new material to the **User Catalog** folder.

For more information, see “Define Material Dialog” on page 306 of the Reference Manual.

## Creating Images

In Home Designer Essentials, image objects are more than just 2D pictures. Images have size and height attributes and can contain transparency information. In floor plan view, they display only as 2D symbols; but in 3D views, the visual information that images contain can be seen.

Images can be placed in a plan just as plants, furnishings and fixtures are: by selecting the image and clicking any floor plan view, camera view or overview.

### *To create an image and save it to the library*

- Right-click on the User Catalog folder, then select **New> Image**  from the contextual menu to open the **Image Specification** dialog. For more information, see “Image Specification Dialog” on page 373 of the Reference Manual.

2. On the Image tab, click the **Browse** button and browse to any image on your computer. In this tutorial we will use an image of a cat that has transparency data associated with it; however, you can use any image.

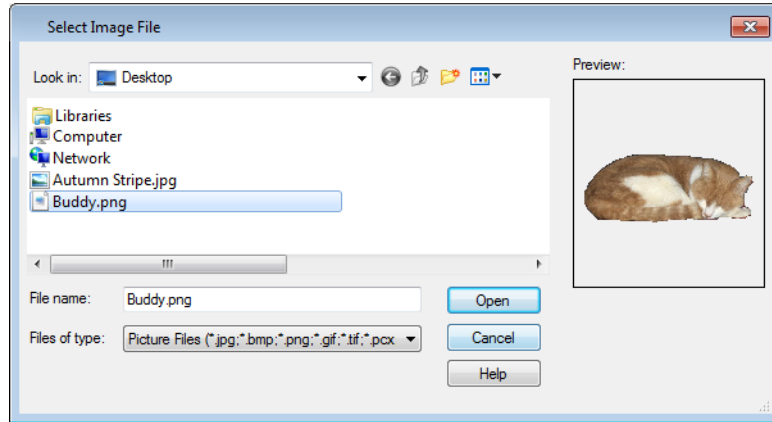

3. Click **Open** to return to the **Image Specification** dialog.
4. On the Image tab, enter the **Height** or **Width**, adjusting one will adjust the other, maintaining the correct proportion. Enter a **Height Above Ground** value to specify the elevation at which the image displays. A value of 24 inches works well in this case as we'll be placing the image on a piece of furniture.
5. Specify the transparency settings on the Transparency tab.
6. Click **OK** to close the **Image Specification** dialog and add the new image to the **My Images** category in the Images library.

## Importing Backdrops

Backdrops are images that display behind 3D views. In Home Designer Essentials, you can take a photo of a site, save it to the library as a backdrop, and display it behind 3D views to create a realistic rendering of your model and its surrounding view.

*To import a backdrop and save it to the library*

1. Select **File> Import> Backdrop**  and browse to an image on your computer.

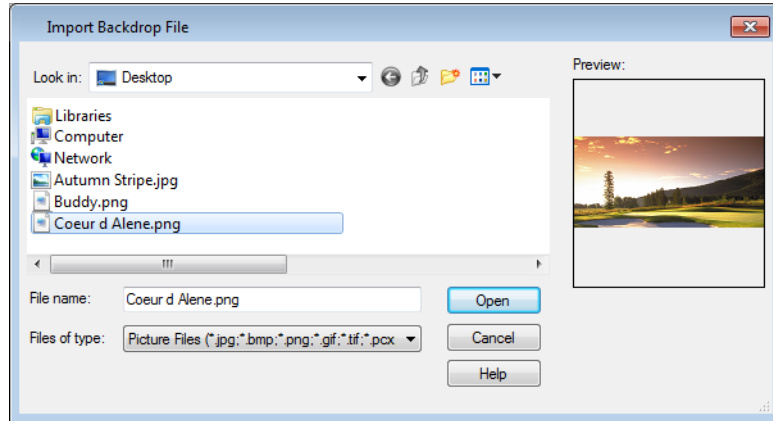

2. Select the image and click **Open** to add it to User Catalog.

*To apply a backdrop to 3D views*

1. Select **3D> 3D Backdrop**  to open the **3D Backdrop** dialog.

2. Click on the **Select Backdrop** button, find and select your backdrop from User Catalog and click **OK**.

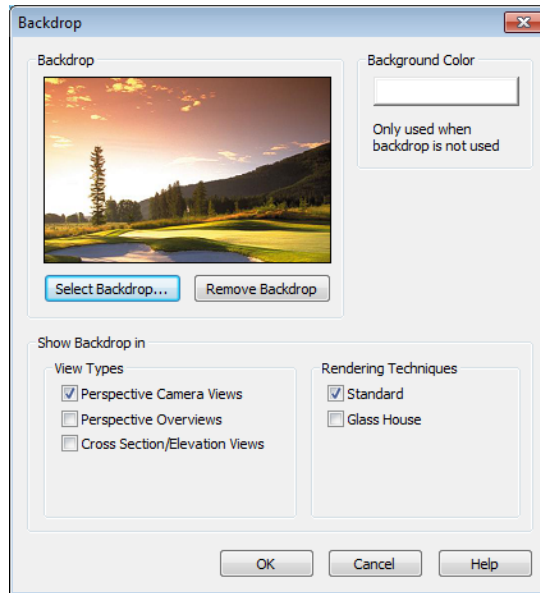

3. Click **OK** to close the **3D Backdrop** dialog.

You can see your custom material, image and backdrop by creating a **Full Camera**  view.





---

## Generating a Materials List

To conclude this tutorial, we'll generate a materials list for the house. For more information, see "Materials Lists" on page 392 of the Reference Manual.

Note: The Materials List is only a rough cost estimate and should be double checked before being relied on.

### *To generate a materials list for the whole plan*

1. Select **Tools> Materials List> Calculate From All Floors** . A materials list is generated for all floors of the house.
2. Locate the an item, such as one under the Fixtures category.
3. Click in the "Price" column type in a value. Notice that the subtotal and Total both update to reflect the pricing change. You can specify prices for every material in your plan, allowing you to generate a cost estimate.
4. If you wish, you can select **File> Export Materials List**  and save the list as a Tab-delimited **.txt** file, which can be opened in a spreadsheet application.
5. Close the materials list by selecting **File> Close Window** from the menu. When you have finished, you may want to **Save**  your work.

You can generate a materials list to estimate the cost of an entire plan or just a portion of a plan. For more information, see "Materials Lists" on page 392 of the Reference Manual.

Note: The Materials List is only a rough cost estimate and should always be double checked before being relied on.





# Landscaping Tutorial

This tutorial was written to help you learn how to use Home Designer Essentials's Terrain tools. In this tutorial, you will learn how to add elevation information to your terrain, how to create terrain features, and how to add plants and other objects from the library.

It is a good idea to become familiar with the terrain tools before beginning your own terrain project.

In this tutorial, you will learn about:

- Creating a Terrain Perimeter
- Adding a Driveway
- Adding Library Objects to Your Plan



This tutorial continues from where the House Design Tutorial left off, so you may want to save this plan using a new name to archive your previous work.

---

## Creating a Terrain Perimeter

The Terrain Perimeter is a closed polyline that defines the boundary of the terrain that generates in 3D views, and of the contour lines that generate in floor plan view. It can also be used to represent a lot boundary. See “Terrain Perimeter” on page 258.

### *To create and resize a terrain perimeter*

1. On Floor 1 of your plan, select **Terrain > Create Terrain Perimeter**  from the menu or click the corresponding toolbar button. See “Toolbar Arrangement” on page 57 of the Reference Manual.
  - If this menu option is not available in a given plan file, a terrain perimeter already exists.
2. Select **Window > Fill Window**  to fill the screen with the terrain perimeter.

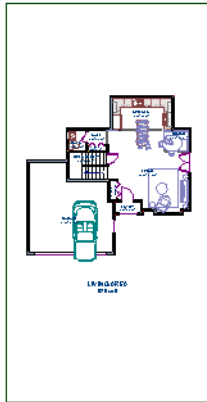

3. Select the terrain perimeter by clicking on either of the vertical edges. Notice that a temporary dimension displays, indicating that the selected edge of the terrain perimeter is 100 feet from the opposite edge.
4. With the terrain perimeter edge selected, click on the temporary dimension. Enter 150 feet using an apostrophe to denote feet (150'). The program will default to inches if no apostrophe is included. For more information about using dimensions to relocate objects, see “Moving Objects Using Dimensions” on page 350 of the Reference Manual.
5. Press the Enter key on your keyboard and repeat this process for the adjacent edge of the terrain perimeter, creating a rectangle that is 150 feet by 200 feet.

6. Click **Window> Fill Window**  to fill the screen with the terrain perimeter.

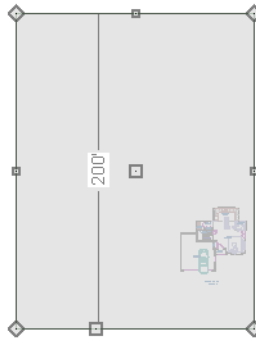



Your house may already be centered on the terrain perimeter. If it is not, you can move it.

***To move the terrain perimeter***

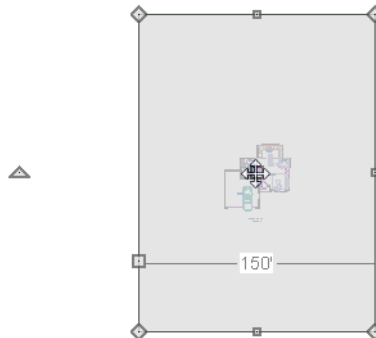
1. Select the terrain perimeter and place your pointer over the move edit handle.
2. Move the terrain perimeter so that the house is centered.



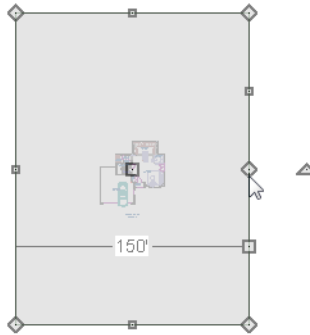

***To edit the shape of the terrain perimeter***

1. In addition to adjusting the size of your rectangular terrain perimeter, you can also use the **Change Line/Arc**  and **Break Line**  edit tools to modify its shape.
2. To place a break on the right segment of the Terrain Perimeter, creating a new corner edit handle at that location, and two separate edges on either side of that handle, use the **Break Line**  edit tool.

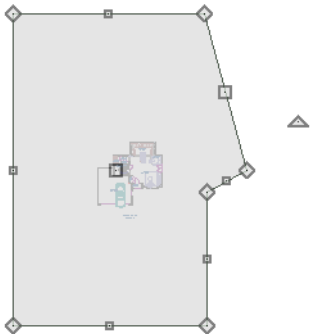

3. You can then use the edit handle to adjust the size and shape of the Terrain Perimeter. For more information, see “Editing Closed-Polyline Based Objects” on page 80 of the Reference Manual.



4. Select the bottom edge of the Terrain Perimeter, and click on the **Change Line/Arc**  edit button, and notice that this segment changes in to an Arc, which can then be modified using its edit handles. For more information on modifying arcs, see “Editing Arc Based Objects” on page 75 of the Reference Manual.

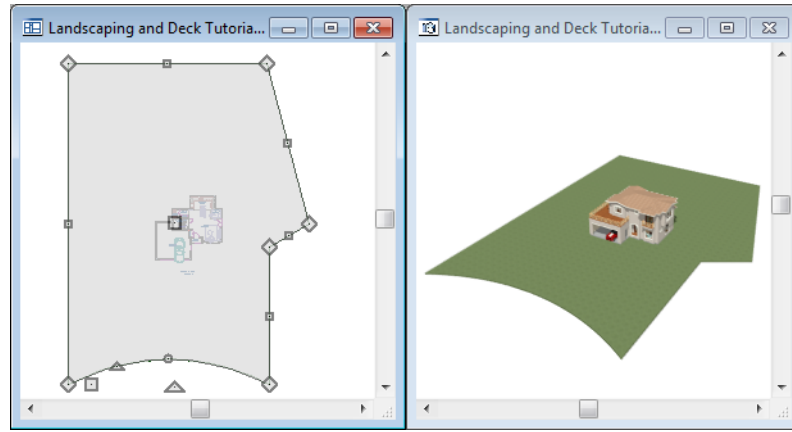



5. Once you have finished modifying your terrain perimeter, you are ready to move on to the next section of the tutorial.

---

## Adding a Driveway

Now we'll add a driveway to our plan.





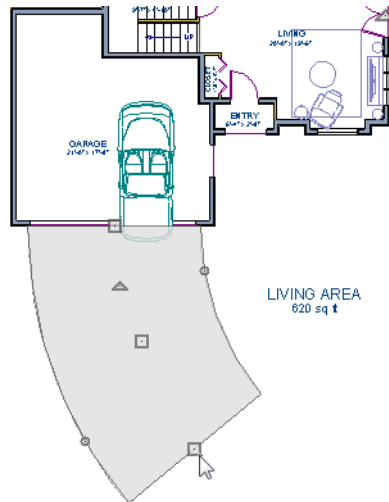

### *To add a driveway to the plan*

1. Select **File> Close** to return to floor plan view. You should still be on Floor 1.
2. Click the **Fill Window**  button to fill your screen with the terrain perimeter.
3. Turn off the display of the layer, "Terrain, Primary Contours". If you cannot remember how to do this, see .
4. Select **Terrain>> Driveway**  then click and drag to draw a driveway.



Once drawn, you can edit the driveway's shape using its edit tools.

*To edit the driveway's shape*

1. Click the **Select Objects**  button, then click on the driveway to select it.
2. Click the **Break Line**  edit button, then click along any edge of the driveway to place a new corner edit handle at that location. The edge that you clicked on becomes divided into two edges that join at the new handle.
3. Continue adding breaks to create as many edges as you wish. Click the **Select Objects** button when you are finished.
4. With the **Select Objects**  tool active, click and drag any of the edit handles that display along the edges of the driveway to adjust its shape and size as needed.
5. If you would like to change a straight edge into a curved edge, click on that edge to select it and click the **Change Line/Arc**  edit button.
6. To change a curved edge back into a straight edge, select it and click the **Change Line/Arc**  edit button once more.
7. Next, add in a **Terrain> Road> Straight Road** and **Terrain> Sidewalk> Straight Sidewalk**  to complete the design.
8. Finally, take a look at your plan in a **Overview** to see the results. Recall that you can select **3D> Final View**  to smooth surface edges and improve the quality of the view.







---



## Adding Terrain Features

Now we'll add a beach, a water line, and a pathway to our plan. For more information about terrain features, see "Terrain Feature Tools" on page 260 of the Reference Manual.

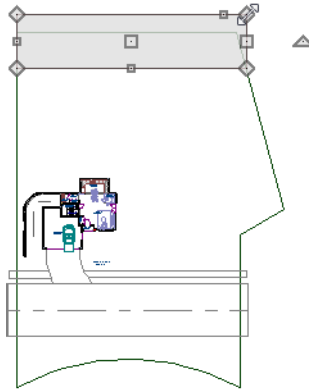
### *To create a beach*

1. Close the overview and return to floor plan view.
2. Select **Window> Fill Window**  then select **Window> Zoom Out**  to give us some working space outside the terrain perimeter.
3. Select **Terrain> Feature> Rectangular Feature**  and draw a terrain feature that extends to the boundaries of the terrain perimeter.



4. Select the terrain feature and the **Open Object**  edit button to open the **Terrain Feature Specification dialog**.
  - On the General tab, the **Height** should be at 0 inches.
  - On the Materials tab, select the terrain feature and click the **Select Material** button to open the **Select Library Object** dialog and assign a sand material from the landscaping library.
  - Click OK to close the **Select Library Object** dialog then click OK to close the **Terrain Feature Specification** dialog and return to floor plan view.
5. With the Terrain Feature still selected, use the **Break Line**  edit tool to place two breaks in the front of the rectangular feature.
6. Next, select one of the segments you have created, and click the **Change Line/Arc**  edit tool, and use the triangular edit handle to adjust the shape of the curved segment, and repeat this procedure for the remaining front segments of the Terrain Feature, as in the image below.

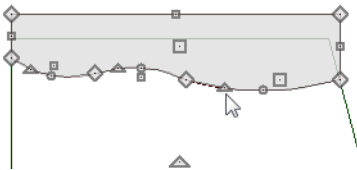

7. Take a look at our new beach in a **Perspective Full Overview** .





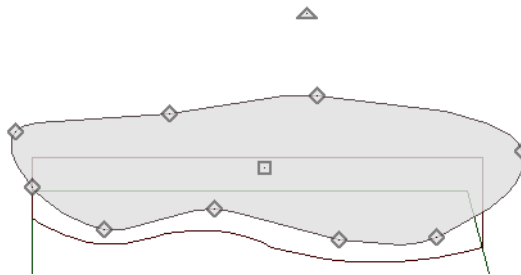

*To create a body of water*

1. Return to floor plan view, select **Terrain > Round Pond**  and draw another spline feature, within the existing terrain feature (the beach) and resize it similar to the image below.



2. Select the pond and click the **Open Object**  edit button. On the General tab of the **Terrain Feature Specification** dialog, raise the **Height** to 1 inch. This will display the water material above the beach.
3. Click OK and take a look in a **Perspective Full Overview** . Notice that only the portion of the terrain feature that is included within the terrain perimeter is modeled.

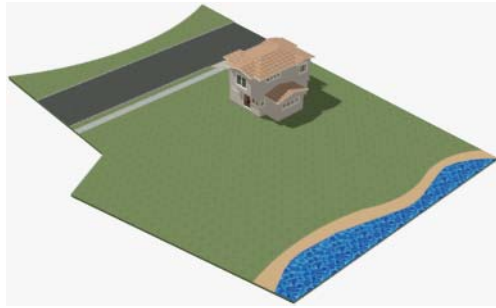

4. Using the method described above, you can quickly see how it is easy to create a terrain features, customize their height, material, shape and even combine them together to create nearly any type of terrain feature you might want in your plan.

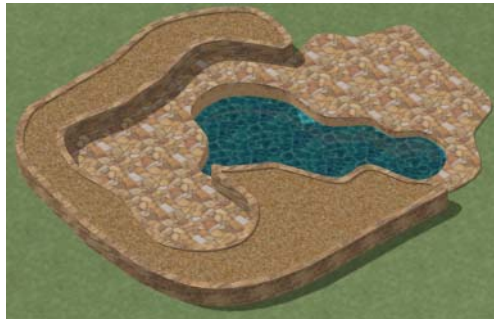





---

## Adding Library Objects to Your Plan

The library contains many objects that can be added to a plan such as plant images and landscaping blocks. There are two ways to find objects in the library: by browsing and by searching. For more information about library objects, see “The Library” on page 282 of the Reference Manual.

### *To browse the Plants library category*

1. If the Library Browser is not open, select **Library > Library Browser**  to open it.
2. Click the + beside Plants to expand this category  and see its contents.
3. Click the + beside Trees to expand this folder  and view its contents, as well.
4. Expand the Deciduous folder and note the many tree species to choose from. Many of these folders contain still more subfolders with different varieties of that species.

5. The Exteriors library contains a selection of landscaping, deck and patio accessories, outdoor furniture, and other objects that you can place in your plan.
6. Once you have completed adding items to your landscaping design, create a **Camera**  view to see the results.





# Deck Tutorial

Now we'll continue where the Landscaping Tutorial left off and create a deck off the back of the house, connecting it to the terrain with an exterior staircase. You may want to save this tutorial using a new name to archive your previous work.

In this tutorial you will learn about:

- Decks and Porches
- Drawing Decks
- Drawing Stairs
- Adding Exterior Furniture

---



## Decks and Porches

Decks and porches are exterior rooms that are defined by the deck railings and exterior walls that enclose them. When an exterior room is drawn using the **Deck Railing**  tool, the room is automatically assigned the exterior room type Deck.



Railings and Deck Railings are drawn just like walls. To illustrate this, we'll add a deck behind the kitchen area. For more information see "The Deck Tools" on page 98 of the Reference Manual.

## Drawing Decks

### *To draw a deck*

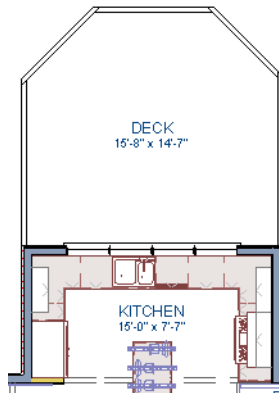
1. To begin, while in floor plan view, let's select **Tools> Display Settings> Display Options**  and uncheck the Disp for both the "Terrain, Elevation Data" and "Plants" layers and click **OK**.
2. In floor plan view, go to the first floor (you may be there already).
3. **Zoom**  in on the back portion of the house.
4. Next select **Build> Deck> Straight Deck Railing** .
5. Draw five deck railings as shown in the following image. The angled railings are drawn at a 45 degree angle to the others. Note that when the mouse is released, the room is assigned the Room Type of Deck and given a room label.



6. When the deck area is enclosed, click the **Select Objects**  button, then click in this room to select it.
7. Click the **Open Object**  edit button to display the Room Specification dialog.
8. On the Structure tab we will set the Floor (C) value to -108" so that it will generate at the door for our walkout basement then click **OK**.
  - Note that Deck rooms by default will not automatically generate a Roof or Ceiling over the room, however, you can still select these options. We will leave the checkboxes alone for the purposes of this tutorial.
9. Now take a look at our first floor deck in a **Camera**  view. You can see that the program automatically generated planking, posts, and beams.





10. Select **Window> Tile Vertically**  to see a side by side of both the 2D and 3D views.

---

## Drawing Stairs

Now we'll draw stairs between the deck to the terrain below. For more information, see "Stairs & Landings" on page 204 of the Reference Manual

### *To connect the upper and lower decks with stairs*

1. In the floor plan view window, make sure that you are on the first floor.
2. Select **Build> Stairs> Click Stairs** .
3. Click just to the outside of the deck platform, as shown in the following image.
4. In most cases when using the Click Stairs tool, an opening will be added automatically to the deck railing at the top of a staircase.
5. If an opening is not created, select **Build> Door> Doorway**  in either floor plan or a 3D view, then click on the deck railing to create an opening in front of the staircase.

---

## Adding Exterior Furniture

Now let's add some furniture to our deck.

### *To add furniture to the deck*

1. Open the Library Browser and browse to Home Designer Core Catalogs> Exteriors> Outdoor Living> Outdoor Furniture> Furniture Sets> Wicker> Wicker Dining Chair and select it for placement. When a library item is selected, a preview image displays.

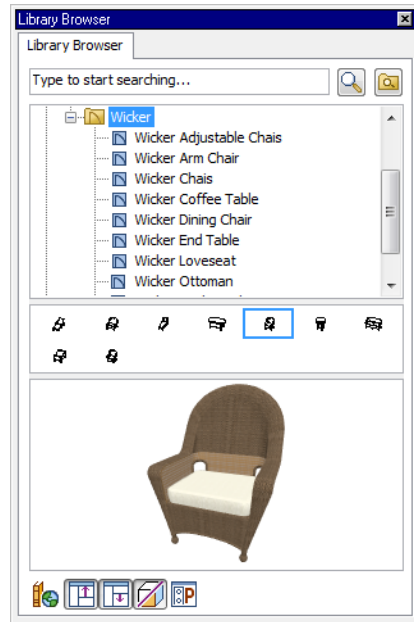

2. In floor plan view or a 3D view, click on the deck to place a chair symbol. You can continue clicking to place more chairs.
3. Find Home Designer Core Catalogs> Exteriors> Outdoor Living> Outdoor Cooking, select a grill for placement, and place it on the deck.
4. Next, add some exterior lighting and any other desired exterior elements to your deck design.
5. Finally, create a Camera view to see the results.





# **End User License Agreement**

**Chief Architect, Inc.**

**End User Software License Agreement for  
Chief Architect® Software**

NOTICE TO USER:

PLEASE READ CAREFULLY: THIS IS A CONTRACT. BY INSTALLING, COPYING OR USING THIS SOFTWARE, YOU AGREE TO BE BOUND BY ALL THE TERMS AND CONDITIONS OF THIS LICENSE AGREEMENT, ON YOUR OWN BEHALF AND ON THE BEHALF OF THE ENTITY BY WHOM YOU ARE EMPLOYED OR REPRESENT. IF YOU DO NOT AGREE WITH THE TERMS OF THIS AGREEMENT, DO NOT INSTALL, USE OR COPY THE SOFTWARE. INSTEAD, RETURN THE SOFTWARE WITHIN THE SPECIFIED GUARANTEE PERIOD TO THE PLACE OF PURCHASE FOR A REFUND OF YOUR PURCHASE PRICE.

This Chief Architect, Inc. End User License Agreement ("License Agreement", or "EULA") is a legal agreement between you (an individual or entity) and Chief Architect, Inc., and sets forth the terms and conditions under which you are licensed to use the Software. "Software" means (A) all of the contents of the CD-ROM(s), DVD(s), electronic download, online media, or any other media which is accompanied by this Agreement, including, but not limited to (i) Chief

Architect or third party software, (ii) printed, "online" or electronic explanatory materials ("Documentation"), (iii) digital images, sample plans, textures, images, symbols, photographs, videos or other artistic works ("Graphical Files"), (B) hardware or software security key, if any, and (C) modified versions, updates, upgrades, downloadable content, additions and copies of the software, if any, licensed to you by Chief Architect, Inc. (collectively, "Updates").

1. GRANT OF LICENSE TO USE SOFTWARE: Chief Architect, Inc. grants you a non-exclusive, non-transferable (except as provided below) license ("License") to use the Software in object code only (and specifically not in source code) subject to the following terms and conditions:

(a)Software: Unless otherwise agreed to in writing, Chief Architect, Inc. grants you the right to use one copy of the Software on only one computer at one location at any one time;

(b)Storage/Network Use: You may store or install the Software on a network server or other storage device only to install and run the Software on an internal network. You must, however, purchase and dedicate a separate license of the Software for each computer and each concurrent user of the Software installed or accessed from a network server or other storage device. A single license for the Software may not be shared or used concurrently on different computers;

(c)Backup: You may make a backup copy of the Software for archival purposes. If printed Documentation accompanies the Software, it may not be copied. If the Software is accompanied by Documentation in electronic form, you may print out one (1) copy for your use which, in turn, may not be copied. A copy of the Software must include all copyright notices and this License Agreement;

(d)If you receive one copy of the Software electronically and a second copy on media, the second copy may be used for archival purposes only and may not be transferred to or used by any other person. This license does not grant you any right to any enhancement or update unless otherwise agreed to in writing by Chief Architect, Inc.;

(e)The Student Edition of the Software must be used only by a student for qualified educational purposes and only while actively studying at a qualified educational institution. The Student Edition of the Software shall not be used for commercial purposes;

(f)The NKBA Exam Version of the Software must be used only by a registered NKBA Exam applicant and only for the purpose of preparing for and taking the NKBA Exam. The NKBA Exam Version has a limited timeout period and cannot be upgraded. The NKBA Exam Version of the Software shall not be used for commercial purposes;

(g)Academic Licenses are licensed for use by educational institutions for educational purposes only. If the Software is licensed as an Academic License and you are not a qualified educational institution using the Software for qualified educational purposes, then your license(s) of the Software are invalid.

2. OTHER RIGHTS AND RESTRICTIONS:

- (a)Reverse Engineering: You may not modify, translate, reverse engineer, decompile, disassemble, or modify the Software in any way or use any other method to convert the Software or any component of the Software into human-readable code, create derivative works based upon the Software, Documentation, or Graphical Files or allow anyone else to do so;
- (b)Renting: You may not rent, lease, sub-license, lend, duplicate or distribute the Software, Documentation, or Graphical Files without the prior written consent of Chief Architect, Inc., which, if given, is subject to the transferee's consent to the terms and conditions of this License Agreement;
- (c)Copying: You may not copy or reproduce the Software, Documentation, or Graphical Files (except for personal back-up purposes);
- (d)Upgrades: If the Software is being licensed to you as an upgrade, renewal, or update to software previously licensed to you, you must cease using the software previously licensed to you, including any copies installed on your computer hard-disk drives, once you have successfully installed and commenced use of the upgrade, renewal, or update software. You may not transfer or sell the software version previously licensed to you. Any unauthorized attempt to transfer or sell the software previously licensed to you will result in automatic termination of your current software license. You may, however, maintain a copy of the software previously licensed to you for archival purposes only;
- (e)The Student Edition has a limited timeout period and cannot be upgraded;
- (f)Proprietary Notices: You may not remove any proprietary notices or labels from the Software, Documentation, or Graphical Files;
- (g)Protection: You may not utilize any computer hardware or software designed to defeat any hardware or software copy-protection device, should the Software be equipped with such protection. You may not disable any copy-protection or security control features of the Software;
- (h)Licensing and Authentication: This Software uses security technology to authenticate your software installation and protect your license from unauthorized use. You agree to allow the Software to send this security information to the Chief Architect security servers for authentication. You may not disable any such security, licensing, or control features of the Software;
- (i)Public Access: You may not copy the Software, Graphical Files, or any component of the Software onto any public network. You may not, in any manner, make it accessible to others, including via internet Web site, telecommunication transmittal, electronic bulletin board, or any other form of electronic distribution system;
- (j)Distribution: This Software and all components of the Software are licensed for your use only. You may not share or distribute the Software to any other party or entity. You may share only images, textures, and symbols used by your design with other licensed users of the software; however, you may not share or distribute these files or exported versions of these

files to any other party or entity for use as library content with other software programs. Use of Chief Architect Graphical Files as library content within other software programs is a violation of this License Agreement.

**3. TRANSFERRING YOUR SOFTWARE:** You may permanently transfer your license to another person or entity only upon written approval by Chief Architect, Inc., and according to the following terms and conditions:

(a) You must fill out, sign, and return to Chief Architect, Inc. the Certificate of Transfer of Ownership prior to any transfer of the Software. This is available through the Chief Architect, Inc.'s Customer Service Department. Call Chief Architect, Inc.'s Customer Service Department prior to any transfer in order to receive this document;

(b) The transferor or transferee must pay to Chief Architect, Inc. a license transfer fee for each license transferred to complete the process of transfer of ownership;

(c) You may permanently transfer a current, valid and eligible license for the Software, for which full price was paid. If you received a discount or rebate on the Software, you must pay to Chief Architect, Inc. the difference in price between your discounted price and the full price of the Software for each license transferred. You must deliver the Software to the transferee in its entirety and must not retain any copy of the Software on any computer or storage media, including backup or archival copies;

(d) You may transfer an Additional License and still retain other licenses of the Software only by paying to Chief Architect, Inc. the difference in price between the full retail price of the Software and the net price paid (including discounts and rebates) for each Additional License transferred;

(e) If you own multiple licenses and you wish to transfer a license, the license to be transferred shall be the license for which you received the largest discount or rebate;

(f) Your License will automatically terminate upon any transfer of the Software;

(g) If the Software being transferred is an Upgrade, you must cease using all prior versions of the Software, Documentation, and Graphical Files as well. You must uninstall all versions of the software and you may not use or retain any copy of any prior version of the Software;

(h) You may not transfer any earlier versions of Software which have been upgraded;

(i) You may not transfer a license of the Software that was purchased under the Chief Architect National Accounts program;

(j) You may not transfer a Not For Resale (NFR) license of the Software. You also may not transfer a Presentation license, a Student license, or an Academic license of the Software;

(k) You may not transfer any NKBA Exam Version license of the Software;

(l) The recipient of the transfer shall agree to all the terms of this License Agreement as a condition of the transfer.

4. TITLE: Title, ownership, rights, and intellectual property rights in and to the Software, Documentation, Graphical Files, and any other accompanying materials shall remain with Chief Architect, Inc. or the respective third party. Title, ownership, rights, and intellectual property rights in and to each of the Sample Drawings and any accompanying materials shall remain with each Licensor from whom Chief Architect, Inc. licensed each Sample Drawing and any accompanying materials. Unauthorized copying of the Software, Documentation, Graphical Files, or Sample Drawings, or failure to comply with the foregoing restrictions, will result in the automatic termination of this License Agreement. Unauthorized duplication of the Software, Documentation, Graphical Files, or Sample Drawings constitutes copyright infringement and in the United States is punishable in a federal criminal action by a fine of up to \$250,000 and imprisonment of up to five (5) years. In addition, federal civil penalties allow the recovery of actual damages based on the number of unauthorized copies produced or statutory damages of up to \$100,000 for willful copyright infringement.

5. THIRD PARTY CONTENT: All trademarks and logos belong to their respective owners. All Graphical Files and Content, including symbols, images, textures, backdrops, text, and videos are the copyright subject matter of Chief Architect, Inc. or third parties. The Graphical Files and Content included with the Software are provided for use with the Software only. You shall not use the Graphical Files or Content included with the Software for any other purpose outside of the Software plan files. You shall not sell or distribute the Graphical Files or Content for any purpose whatsoever. You shall not use the Graphical Files or Content with other software. Chief Architect, Inc. and third party content, symbols, text, or textures shall not be copied, redistributed, or sold separately from the Software. Chief Architect, Inc. and third party product content is provided for representational purposes only. Chief Architect, Inc. and third parties assume no responsibility for any discrepancies between actual product appearance and that represented in the Software, or between actual pricing, characteristics, and specifications, and that mentioned anywhere in the Software or Documentation.

6. MONEY-BACK GUARANTEE PERIOD: The Software has a money-back guarantee for satisfaction. During the money-back guarantee period (the "Guarantee Period") following your first purchase of the Software, you may request to return the Software, Documentation, Security Device (if any), and packaging, along with the original purchase receipt, for a refund of the purchase price, less any applicable shipping fees, taxes, duties, discounts, and rebates paid. This money-back guarantee does not apply to license transfers. You agree to contact Chief Architect, Inc. in order to obtain and perform proper return material authorization ("RMA") steps prior to returning the Software. You also agree to uninstall and deactivate the Software and all of its related files and content from your computer prior to returning the product.

If, after returning the Software, Documentation, Security Device (if any), and packaging for a refund, you repurchase any version of the Software again, you are, by the act of repurchasing the Software, acknowledging satisfaction with the Software, and by doing so agree to purchase and keep the Software permanently without the option to return it for a refund.

7. GRANT OF LICENSE TO USE SAMPLE DRAWINGS: Chief Architect, Inc. has licensed from third parties (the "Licensors") sample drawings that may be included in the Software. These Sample Drawings are provided to you by Chief Architect, Inc. solely for demonstrative and illustrative purposes to help you more quickly learn and better understand the functional capabilities of the Software, and are licensed to you solely for these limited purposes. You may not reproduce, distribute or use these Sample Drawings for any other purpose without the prior written consent of Chief Architect, Inc. and the Licensor(s) from whom these Sample Drawings were licensed by Chief Architect, Inc..

8. LIMITED SOFTWARE WARRANTY: Chief Architect, Inc. warrants that for a period of sixty (60) days from the date of your purchase of the Software as evidenced by an original copy of your receipt, the media upon which the Software is furnished will be free from defects in materials and workmanship under normal use. EXCEPT FOR THE ABOVE EXPRESS LIMITED WARRANTIES, CHIEF ARCHITECT, INC. MAKES NO WARRANTIES AS TO THE SOFTWARE, EXPRESS, IMPLIED, STATUTORY, OR IN ANY COMMUNICATION WITH YOU. CHIEF ARCHITECT, INC. SPECIFICALLY DISCLAIMS ANY OTHER WARRANTY INCLUDING THE IMPLIED WARRANTY OF MERCHANTABILITY OR FITNESS FOR A PARTICULAR PURPOSE WITH REGARD TO THE SOFTWARE, AND THE ACCOMPANYING WRITTEN MATERIALS. CHIEF ARCHITECT, INC. DOES NOT WARRANT THAT YOUR USE OF THE SOFTWARE WILL BE UNINTERRUPTED OR THAT THE OPERATION OF THE SOFTWARE WILL BE ERROR-FREE. If this Software was purchased in the United States, the above exclusions may not apply to you as some states do not allow the exclusion of implied warranties. In addition to the above warranty rights, you may also have other rights, which vary from state to state.

9. CUSTOMER REMEDIES: The entire liability of Chief Architect, Inc. and your exclusive remedy under the warranty provided as to Software set forth above will be, at Chief Architect, Inc.'s sole discretion: (i) to replace the media; (ii) to attempt to correct or work around software media errors, if any; or (iii) if the above remedies are impracticable to refund the license fee you paid, if any, for the Software. The latter remedy is subject to pre-authorized return of the Software, Documentation, Security Device (if any) and packaging to Chief Architect, Inc. or to the Authorized Chief Architect, Inc. Dealer or Reseller from whom the Product was obtained together with an original copy of your receipt.

Repaired, corrected or replaced software media and documentation shall be covered by this limited warranty for the period remaining under the warranty that covered the original Software or, if longer, for thirty (30) days after the date Chief Architect, Inc. shipped the repaired or replaced software media or documentation to you. Only if you inform Chief Architect, Inc. of the problem with the software media or documentation during the applicable warranty period and provide evidence of the date you acquired the Software will Chief Architect, Inc. honor this warranty.

10. NO WARRANTY AS TO THE SAMPLE DRAWINGS, SAMPLE PLANS, LIBRARY CONTENT, OR VIDEOS: CHIEF ARCHITECT, INC. MAKES NO WARRANTY

WHATSOEVER AS TO THE SAMPLE DRAWINGS, SAMPLE PLANS, LIBRARY CONTENT, OR TRAINING VIDEOS WHICH ARE PROVIDED TO YOU SOLELY FOR DEMONSTRATIVE AND ILLUSTRATIVE PURPOSES. CHIEF ARCHITECT, INC. MAKES NO WARRANTY THAT THE DIMENSIONS IN THE SAMPLE DRAWINGS, SAMPLE PLANS, LIBRARY CONTENT, OR VIDEOS ARE ACCURATE AND FREE OF DISCREPANCIES. CHIEF ARCHITECT, INC. MAKES NO WARRANTY THAT THE LIBRARY CONTENT, SAMPLE DRAWINGS, OR SAMPLE PLANS COMPLY WITH ANY BUILDING CODES. THE LIBRARY CONTENT, SAMPLE DRAWINGS, AND SAMPLE PLANS ARE PROVIDED TO YOU "AS IS," AND CHIEF ARCHITECT, INC. AND THE LICENSORS OF THE LIBRARY CONTENT, SAMPLE DRAWINGS, AND SAMPLE PLANS DISCLAIM ANY AND ALL WARRANTIES WITH RESPECT TO THE LIBRARY CONTENT, SAMPLE DRAWINGS, AND SAMPLE PLANS, WHETHER EXPRESS OR IMPLIED OR ARISING BY CUSTOM OR TRADE USAGE, AND, SPECIFICALLY, MAKE NO WARRANTY OF MERCHANTABILITY OR FITNESS FOR ANY PARTICULAR PURPOSE.

11. DISCLAIMER AND LIMITATION OF LIABILITY: COMPUTER-AIDED DESIGN SOFTWARE AND OTHER TECHNICAL SOFTWARE ARE TOOLS INTENDED TO BE USED BY TRAINED AND EXPERIENCED INDIVIDUALS ONLY. THEY ARE NOT SUBSTITUTES FOR YOUR TRAINED, EXPERIENCED AND PRACTICAL JUDGMENT. COMPUTER-AIDED DESIGN SOFTWARE AND OTHER TECHNICAL SOFTWARE ARE INTENDED TO ASSIST WITH ARCHITECTURAL, PREMISES OR PRODUCT DESIGN AND ARE NOT SUBSTITUTES FOR INDEPENDENT TESTING OF STRUCTURAL INTEGRITY, ENGINEERING, SOUNDNESS, SAFETY, AND UTILITY. DUE TO THE LARGE VARIETY OF POTENTIAL APPLICATIONS FOR THE SOFTWARE, THE SOFTWARE HAS NOT BEEN TESTED IN ALL SITUATIONS UNDER WHICH IT MAY BE USED. CHIEF ARCHITECT, INC. SHALL NOT BE LIABLE IN ANY MANNER WHATSOEVER FOR THE RESULTS OBTAINED THROUGH THE USE OF THE SOFTWARE. PERSONS USING THE SOFTWARE ARE RESPONSIBLE FOR THE SUPERVISION, MANAGEMENT AND CONTROL OF THE SOFTWARE AND THEIR EMPLOYEES OR CONTRACTORS WHO USE THE SOFTWARE. THIS RESPONSIBILITY INCLUDES, BUT IS NOT LIMITED TO, THE DETERMINATION OF APPROPRIATE USES FOR THE SOFTWARE AND THE SELECTION OF THE SOFTWARE AND OTHER PROGRAMS TO ACHIEVE INTENDED RESULTS. PERSONS USING THE SOFTWARE ARE ALSO RESPONSIBLE FOR ESTABLISHING THE ADEQUACY OF INDEPENDENT PROCEDURES FOR TESTING THE RELIABILITY AND ACCURACY OF ANY PROGRAM OUTPUT, INCLUDING ALL ITEMS DESIGNED OR MEASURED BY USING THE SOFTWARE.

UNDER NO CIRCUMSTANCES WILL CHIEF ARCHITECT, INC., ITS DEALERS, RESELLERS, DISTRIBUTORS, OR THE LICENSORS OF THE GRAPHICAL FILES, SAMPLE DRAWINGS, AND SAMPLE PLANS BE LIABLE FOR ANY DAMAGES, WHETHER ARISING FROM TORT OR CONTRACT, INCLUDING LOSS OF DATA,

LOST PROFITS, COST OF COVER, OR OTHER SPECIAL, INCIDENTAL, CONSEQUENTIAL OR INDIRECT DAMAGES ARISING OUT OF THE USE OR INABILITY TO USE THE SOFTWARE, DOCUMENTATION, GRAPHICAL FILES, OR THE SAMPLE DRAWINGS AND SAMPLE PLANS. CHIEF ARCHITECT, INC., ITS DEALERS, RESELLERS, DISTRIBUTORS, AND THE LICENSORS OF THE GRAPHICAL FILES, SAMPLE DRAWINGS, AND SAMPLE PLANS ASSUME NO LIABILITY OR RESPONSIBILITY FOR, AMONG OTHER THINGS, INADVERTENT DISCREPANCIES, CONSTRUCTION INTERPRETATIONS OR CONSTRUCTED RESULTS. THESE LIMITATIONS WILL APPLY EVEN IF CHIEF ARCHITECT, INC., ITS DEALERS, RESELLERS, DISTRIBUTORS, OR THE LICENSORS OF THE GRAPHICAL FILES, SAMPLE DRAWINGS, AND SAMPLE PLANS HAVE BEEN ADVISED OF THE POSSIBILITY OF SUCH DAMAGE. YOU ACKNOWLEDGE THAT THE LICENSE FEE REFLECTS THIS ALLOCATION OF RISK. FURTHER, IN NO EVENT SHALL THE LIABILITY OF CHIEF ARCHITECT, INC., ITS DEALERS, RESELLERS, DISTRIBUTORS, AND THE LICENSORS OF THE GRAPHICAL FILES, SAMPLE DRAWINGS, AND SAMPLE PLANS UNDER ANY PROVISION OF THIS AGREEMENT EXCEED THE LICENSE FEE PAID TO CHIEF ARCHITECT, INC. FOR THE SOFTWARE, DOCUMENTATION, GRAPHICAL FILES, AND THE SAMPLE DRAWINGS AND SAMPLE PLANS. BECAUSE SOME STATES DO NOT ALLOW THE EXCLUSION OR LIMITATION OF LIABILITY FOR CONSEQUENTIAL OR INCIDENTAL DAMAGES, THE ABOVE LIMITATION MAY NOT APPLY TO YOU.

12. **TERMINATION:** This license shall terminate automatically if you fail to comply with the terms, conditions, and limitations described in this license. No notice shall be required from Chief Architect, Inc. to effectuate such termination. Upon termination, you must immediately uninstall and deactivate the Software. You must also return or destroy all copies of the Software and Documentation.

13. **U.S. GOVERNMENT RESTRICTED RIGHTS:** The Software and Documentation are provided with RESTRICTED RIGHTS for U.S. Government customers. Use, duplication or disclosure by the Government is subject to restrictions as set forth in subparagraph (c)(1)(ii) of The Rights in Technical Data and Computer Software clause at DFARS 252.227-7013 or subparagraphs (c)(i) and (2) of the Commercial Computer Software-Restricted Rights at 48 CFR 52.227-19 as applicable. The manufacturer is Chief Architect, Inc., 6500 N. Mineral Dr., Coeur d'Alene, Idaho 83815.

14. **GOVERNING LAW:** This License Agreement shall be governed by the laws of the State of Idaho without regard to conflicts of law principles. This License Agreement shall not be governed by the United Nations Convention of Contracts for the International Sale of Goods, the application of which is hereby expressly excluded. If either you or Chief Architect, Inc. employs attorneys to enforce any right arising out of this Agreement, the prevailing party shall be entitled to recover reasonable attorney's fees and costs.



15. ENTIRE AGREEMENT: This agreement constitutes the complete and exclusive agreement between you and Chief Architect, Inc. with respect to the subject matter hereof and supersedes all prior oral or written understandings, communications or agreements not specifically incorporated herein. This agreement may not be modified except in a writing duly signed by an authorized representative of Chief Architect, Inc. and you. THE ACCEPTANCE OF ANY PURCHASE ORDER PLACED BY YOU IS EXPRESSLY MADE CONDITIONAL ON YOUR CONSENT TO THE TERMS SET FORTH HEREIN.



# Index

## Numerics

<b>3D Backdrops Dialog</b> .....	133
<b>3D Views</b>	
Create .....	42

## A

<b>Adding</b>	
Floors .....	45
Foundations .....	45
Library Objects .....	146
<b>Appliances</b> .....	108
<b>Artwork</b>	
Adding .....	125
<b>Auto</b>	
Check for Program Updates .....	20
Exterior Dimensions .....	32
Stairwell .....	52

## B

<b>Backdrops</b>	
Importing .....	132
Selecting .....	133
<b>Base</b>	
Moldings .....	100
<b>Basements</b> .....	45
<b>Blend Colors with Materials</b> .....	126
<b>Break</b>	
Wall .....	82

## C

<b>Cabinets</b>	
Base .....	103
Corner .....	105
Creating .....	103
Editing .....	104
Soffits .....	107
Wall, placing .....	106
<b>Camera</b>	
Views, Creating .....	42
<b>Carpet</b>	
Adding .....	124
<b>Chair Rail</b> .....	100
<b>Corner</b>	
Cabinet .....	105
<b>Cross Section Slider</b> .....	117
<b>Crown Molding</b>	
Adding to rooms .....	99

## D

<b>Deck</b>	
Railing .....	150
<b>Decks</b>	
Drawing .....	150
<b>Defaults</b>	
Material .....	120
<b>Dimensions</b> .....	32
Auto Exterior .....	32
<b>Doors</b>	
Adding .....	55
Copying .....	58
Editing .....	55
Placing .....	55

<b>Dormers</b> .....	77
Manually Drawn .....	75

## F

<b>Final View</b> .....	117
<b>Foundation</b>	
Creating.....	45
<b>Furniture</b> .....	151

## G

<b>Gable</b>	
Over Door/Window .....	74
Roofs.....	64
<b>Gambrel Roofs</b> .....	67
<b>Gull Wing Roofs</b> .....	68

## H

<b>Half Hip Roofs</b> .....	69
<b>Hip</b>	
Roofs.....	63

## I

<b>Image</b>	
Specification Dialog .....	132
<b>Images</b>	
Creating.....	131
<b>Installation</b> .....	7
<b>Invisible Walls</b> .....	38

## L

<b>Library Objects</b>	
Placing .....	94
<b>Library Search</b> .....	96

## M

<b>Mansard Roofs</b> .....	71
<b>Material</b>	
Defaults .....	120
Eyedropper.....	127
<b>Material Painter</b> .....	123
Blending.....	126
<b>Materials</b>	
Applying.....	121
Artwork .....	125
Blending.....	126
Changing .....	121
Creating .....	129
<b>Materials Defaults</b> .....	119
<b>Materials List</b> .....	135
<b>Materials Tab</b> .....	121
<b>Merging Walls</b> .....	46
<b>Molding</b> .....	98
<b>Mouse-Orbit Camera</b> .....	44, 54

## O

<b>Open</b>	
Plan .....	25

## P

<b>Plan</b>	
Templates .....	26
<b>Ponds</b> .....	145
<b>Program Updates</b>	
Auto Check.....	20

## R

<b>Reference</b>	
Display.....	46
<b>Roof Type Quick Reference</b> .....	73
<b>Roofs</b>	

Gable .....	64
Gambrel .....	67
Gull Wing.....	68
Half Hip .....	69
Hip .....	63
Mansard .....	71
Manual Dormers.....	75
Saltbox .....	66
Shed .....	65
<b>Rooms</b>	
Creating .....	35
Room Labels.....	40
Room Types .....	40
Selecting .....	122
<b>Rugs</b>	
Area rugs, creating.....	125

## S

<b>Saltbox Roofs</b> .....	66
<b>Select</b>	
Room .....	122
<b>Shed</b>	
Roofs .....	65
<b>Skylights</b>	
Creating .....	81
<b>Soffits</b> .....	107
<b>Stair Designer</b> .....	50
<b>Stair Landing</b>	
Creating .....	50
<b>Stairs</b>	
Drawing .....	151
<b>Stairwell</b> .....	52
Create manually .....	52
<b>Starting the Program</b> .....	24
<b>Startup Options</b> .....	24

## T

<b>Templates</b> .....	26
------------------------	----

## U

### Updates

Auto Check .....	20
------------------	----

## W

### Wall

Cabinets, placing.....	106
------------------------	-----

### Walls

Drawing .....	29
Merging .....	46

### Water Features .....

.....	145
-------	-----

### Windows

Copying .....	58
Editing .....	56
Placing .....	55

